

Technical data

Ex-e Cable glands | Blanking plugs | Reducing rings

Marking to 94/9/EC	Ex II 2 G Ex e II / Ex II 2 D Ex tD A21 IP66
EC-Type Examination Certificate of conformity	M12-M16: PTB 99 ATEX 3101 X / M20-M63: PTB 99 ATEX 3128 X
IECEX Certification of conformity	IECEX PTB 05.0004X
Marking accd. to IECEx	Ex e II
Permissible ambient temperature	-20 °C to +70 °C -55 °C to +70 °C option
Degree of protection accd. EN 60529	IP66 / IP68: 1 m water depth for 0.5 h
Enclosure material	Polyamide

Ex-e Screw plug

Marking to 94/9/EC	Ex II 2 G Ex e II / Ex II 2 D Ex tD A21 IP66
EC-Type Examination Certificate of conformity	M20-M50: PTB 98 ATEX 3130 / M63: PTB 03 ATEX 1058 (nur II 2 G)
IECEX Certification of conformity	IECEX PTB 03.0000 (M20 - M50)
Marking accd. to IECEx	Ex e II
Permissible ambient temperature	M20-M50: -55 °C to +55 °C / M63: -20 °C to +55 °C
Degree of protection accd. EN 60529	IP66 / IP68: 1 m water depth 0.5 h
Enclosure material	Polyamide

Ex-cable glands

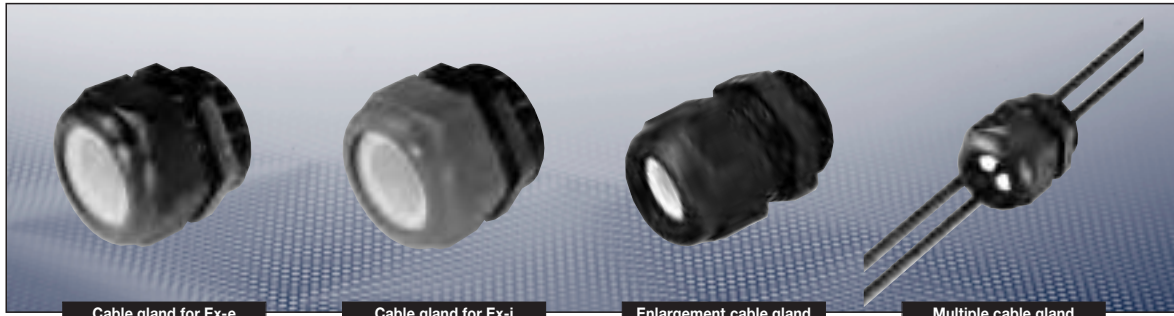

Ordering details

Thread	Cable Ø mm	A/F mm	L1 mm	L2 mm	Weight approx. kg	OU	Order No.
Ex-e cable glands with short thread accd. to EN 50262							
M12 x 1.5	4 - 7	15	19.3	8	0.003	20	GHG 960 1955 R 0001
M16 x 1.5	5.5 - 10	20	23.0	8	0.006	20	GHG 960 1955 R 0002
M20 x 1.5	5.5 - 13	24	25.0	8	0.009	20	GHG 960 1955 R 0003
M25 x 1.5	8 - 17	29	29.5	8	0.017	20	GHG 960 1955 R 0004
M32 x 1.5	12 - 21	36	35.5	10	0.026	20	GHG 960 1955 R 0005

Ex-e cable glands with long thread							
M12 x 1.5	4 - 7	15	19.3	12	0.003	20	GHG 960 1955 R 0021
M16 x 1.5	5.5 - 10	20	23.0	12	0.007	20	GHG 960 1955 R 0022
M20 x 1.5	5.5 - 13	24	25.0	13	0.010	20	GHG 960 1955 R 0023
M25 x 1.5	8 - 17	29	29.5	13	0.018	20	GHG 960 1955 R 0024
M32 x 1.5	12 - 21	36	35.5	15	0.029	20	GHG 960 1955 R 0025
M40 x 1.5	17 - 28	46	39.5	15	0.046	10	GHG 960 1955 R 0026
M50 x 1.5	22 - 35	55	44.0	16	0.073	10	GHG 960 1955 R 0027
M63 x 1.5	27 - 48	68	47.0	16	0.116	5	GHG 960 1955 R 0028

Ex-i cable glands with short thread							
M12 x 1.5	4 - 7	15	19.3	8	0.003	20	GHG 960 1955 R0101
M16 x 1.5	5.5 - 10	20	23.0	8	0.006	20	GHG 960 1955 R0102
M20 x 1.5	5.5 - 13	24	25.0	8	0.009	20	GHG 960 1955 R0103
M25 x 1.5	8 - 17	29	29.5	8	0.017	20	GHG 960 1955 R0104
M32 x 1.5	12 - 21	36	35.5	10	0.026	20	GHG 960 1955 R0105

Ex-i cable glands with long thread							
M12 x 1.5	4 - 7	15	19.3	12	0.003	20	GHG 960 1955 R0121
M16 x 1.5	5.5 - 10	20	23.0	12	0.007	20	GHG 960 1955 R0122
M20 x 1.5	5.5 - 13	24	25.0	13	0.010	20	GHG 960 1955 R0123
M25 x 1.5	8 - 17	29	29.5	13	0.018	20	GHG 960 1955 R0124
M32 x 1.5	12 - 21	36	35.5	15	0.029	20	GHG 960 1955 R0125
M40 x 1.5	17 - 28	46	39.5	15	0.046	10	GHG 960 1955 R0126
M50 x 1.5	22 - 35	55	44.0	16	0.073	10	GHG 960 1955 R0127
M63 x 1.5	27 - 48	68	47.0	16	0.116	5	GHG 960 1955 R0128

Enlargement cable glands (reduced thread diameter)							
M16/M20	5,5 - 13	24	25.0	12	0.010	20	GHG 960 1956 R0002
M20/M25	8 - 17	29	29.5	13	0.018	20	GHG 960 1956 R0003
M25/M32	12 - 21	36	35.5	13	0.029	20	GHG 960 1956 R0004
M32/M40	16 - 28	46	39.5	15	0.046	10	GHG 960 1956 R0005
M40/M50	21 - 35	55	44.0	15	0.073	10	GHG 960 1956 R0006
M50/M63	27 - 48	68	47.0	16	0.116	5	GHG 960 1956 R0007

Multiple cable glands							
M25 x 1.5	2 x 4.5 - 7	29	29.5	8	0.340	20	GHG 960 1955 R0054
M32 x 1.5	4 x 4.5 - 7	36	35.5	10	0.540	20	GHG 960 1955 R0055

Cable glands with PG-thread are available on request.

The order No. will show 1 pcs.

Please note that only order units (OU) can be ordered.

| Ex-cable glands |

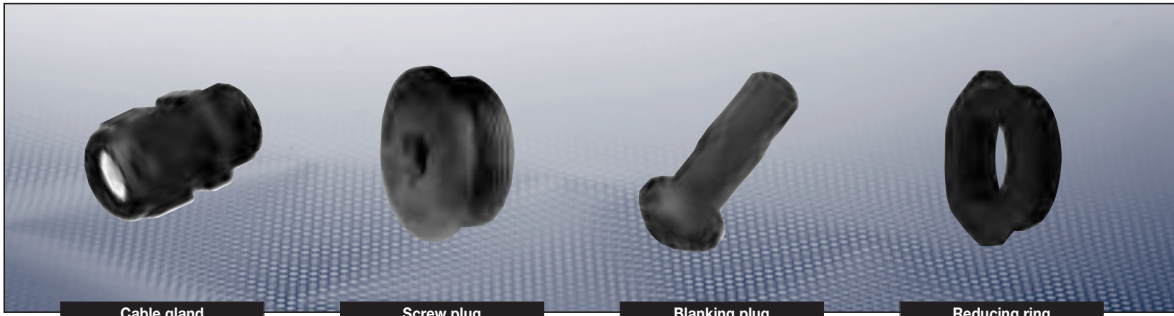

Dimensions drawing

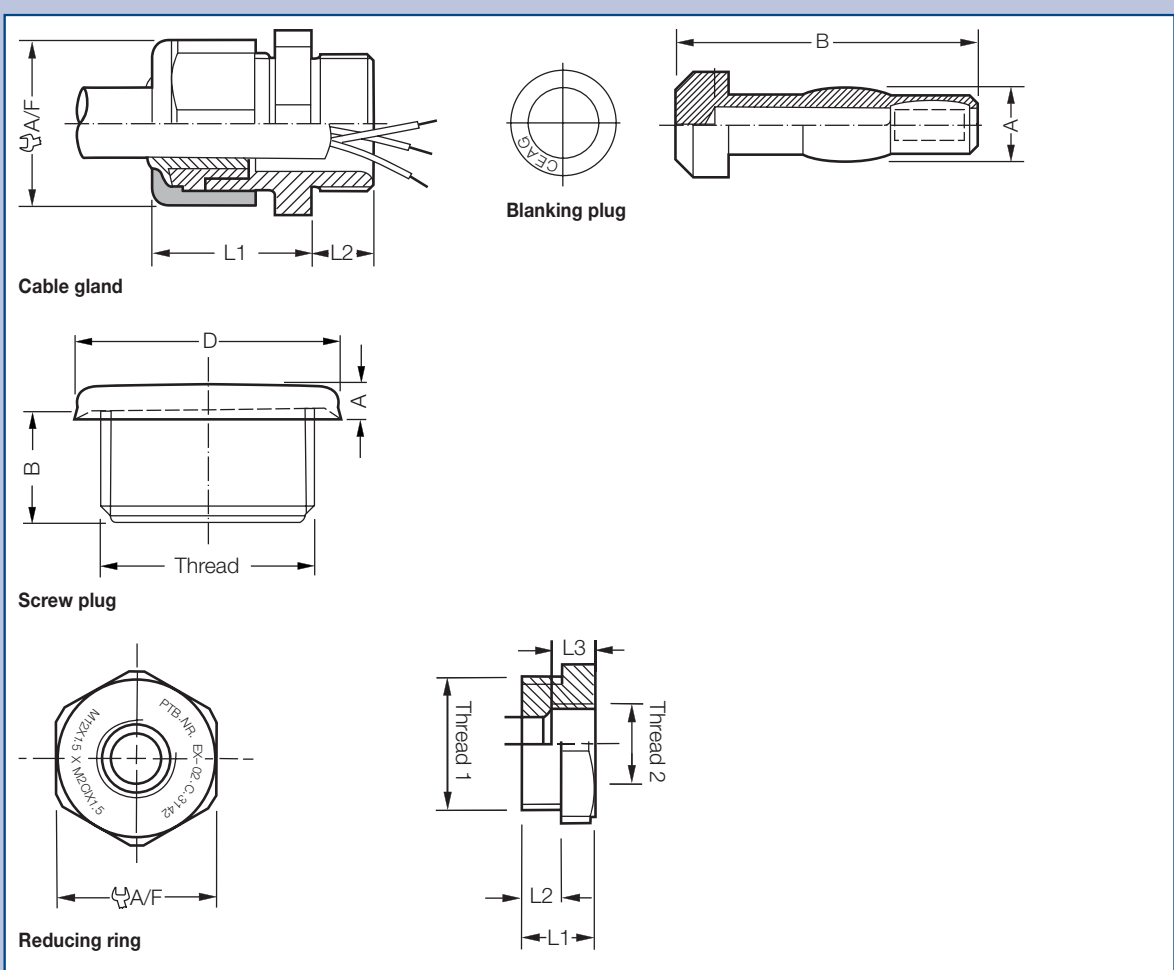

Cooper Crouse-Hinds © 2009 - all rights reserved

Dimensions in mm

Presse étoupe EEx-e PA noir M20 filetage long