

Bar or cable-through CT

References



Primary	Secondary ⁽¹⁾	TCB 17-20		TCB 26-30		T2CB 26-30		TCB 28-30	
		Class	Reference	Class	Reference	Class	Reference	Class	Reference
50 A	5 A				1 VA	192T 2305		1 VA	192T 2405
60 A	5 A	1 VA	192T 2106		1 VA	192T 2306		1.25 VA	192T 2406
75 A	5 A	1 VA	192T 2107		1.5 VA	192T 2307		2.5 VA	192T 2407
80 A	5 A	1.25 VA	192T 2108		2.5 VA	192T 2308		2.5 VA	192T 2408
100 A	5 A	1.5 VA	192T 2110	1.5 VA		192T 2310		2.5 VA	192T 2410
125 A	5 A	1.5 VA	192T 2112	1.5 VA		192T 2312		5 VA	192T 2412
150 A	5 A	2.5 VA	192T 2115	1.5 VA		192T 2315	1.5 VA	5 VA	192T 2415
160 A	5 A	2.5 VA	192T 2116						
200 A	5 A	2.5 VA	192T 2120	2.5 VA		192T 2320	2.5 VA	5 VA	192T 2420
250 A	5 A	5 VA	192T 2125	5 VA		192T 2325	2.5 VA	5 VA	192T 2425
300 A	5 A	5 VA	192T 2130	5 VA		192T 2330	5 VA	5 VA	192T 2430
400 A	5 A	10 VA	192T 2140	5 VA		192T 2340	5 VA	10 VA	192T 2440
500 A	5 A			5 VA		192T 2350	5 VA	10 VA	192T 2450
600 A	5 A			5 VA		192T 2360	5 VA	10 VA	192T 2460
750 A	5 A			5 VA		192T 2375	5 VA	192U 2375	

(1) Secondary 1 A: on request.



Primary	Secondary ⁽¹⁾	TCB 26-40		TCB 32-40		T2CB 32-40	
		Class	Reference	Class	Reference	Class	Reference
50 A	5 A				1.5 VA	192T 4005	
60 A	5 A				1.5 VA	192T 4006	
75 A	5 A				2.5 VA	192T 4007	
100 A	5 A	1.5 VA	192T 3210	2.5 VA		192T 4010	
125 A	5 A	2.5 VA	192T 3212	2.5 VA		192T 4012	
150 A	5 A	2.5 VA	192T 3215	2.5 VA		192T 4015	
160 A	5 A	2.5 VA	192T 3216				
200 A	5 A	2.5 VA	192T 3220	5 VA		192T 4020	2.5 VA
250 A	5 A	5 VA	192T 3225	5 VA		192T 4025	5 VA
300 A	5 A	5 VA	192T 3230	10 VA		192T 4030	5 VA
400 A	5 A	5 VA	192T 3240	10 VA		192T 4040	5 VA
500 A	5 A	10 VA	192T 3250	10 VA		192T 4050	7.5 VA
600 A	5 A	10 VA	192T 3260	10 VA		192T 4060	7.5 VA
750 A	5 A	15 VA	192T 3275	10 VA		192T 4075	7.5 VA
800 A	5 A	15 VA	192T 3280	15 VA		192T 4080	
1000 A	5 A			15 VA		192T 4090	

(1) Secondary 1 A: on request.

Accessories

Description of accessories	TCB 17-20 Reference	TCB 26-30 Reference	TCB 26-40 Reference	TCB 32-40 Reference
DIN rail mounting	192T 0007	192T 0003	192T 0003	192T 0005
Sealable cover		192T 0105	192T 0105	192T 0103

CT Plug-in transducer (CEA-VA)		TCB 26-30 Reference	TCB 26-40 Reference	TCB 32-40 Reference
Power supply	Output			
Self supplied	0-20 mA / 0-10 VDC	192Y 0015	192Y 0015	192Y 0035
230 VAC	0-20 mA / 0-10 VDC	192Y 0215	192Y 0215	192Y 0235
24 VDC	0-20 mA / 0-10 VDC	192Y 0115	192Y 0115	192Y 0135

CT Plug-in transducer (CEA-VA4)		TCB 26-30 Reference	TCB 26-40 Reference	TCB 32-40 Reference
Power supply	Output			
230 VAC	4-20 mA / 0-10 VDC	192T 0255	192T 0255	192Y 0275
24 VDC	4-20 mA / 0-10 VDC	192Y 0155	192Y 0155	192Y 0175

Bar or cable-through CT

References



Primary	Secondary ⁽¹⁾	TCB 44-50		TCB 44-63		T2CB 44-63	
		Class 0.5	Class 1	Class 0.5	Reference	Class 0.2s	Reference
100 A	5 A		1.5 VA		192T 5010		
150 A	5 A	1.5 VA			192T 5015		
200 A	5 A	2.5 VA		1.5 VA	192T 5020	192T 6420	
250 A	5 A	5 VA		1.5 VA	192T 5025	192T 6425	
300 A	5 A	5 VA		2.5 VA	192T 5030	192T 6430	5 VA 192U 6430
400 A	5 A	10 VA		5 VA	192T 5040	192T 6440	5 VA 192U 6440
500 A	5 A	10 VA		10 VA	192T 5050	192T 6450	7.5 VA 192U 6450
600 A	5 A	10 VA		10 VA	192T 5060	192T 6460	7.5 VA 192U 6460
750 A	5 A	10 VA		10 VA	192T 5075	192T 6475	7.5 VA 192U 6475
800 A	5 A	15 VA		10 VA	192T 5080	192T 6480	
1000 A	5 A	15 VA		15 VA	192T 5090	192T 6490	7.5 VA 192U 6490
1200 A	5 A	15 VA		15 VA	192T 5092	192T 6492	7.5 VA 192U 6492
1250 A	5 A	15 VA		15 VA	192T 5095	192T 6493	7.5 VA 192U 6493
1500 A	5 A			15 VA	192T 6495	7.5 VA	192U 6495
1600 A	5 A			15 VA	192T 6494		

(1) Secondary 1 A: on request.



Primary	Secondary ⁽¹⁾	TCB 55-80		TCB 85-100		TCB 100-125	
		Class 0.5	Reference	Class 0.5	Reference	Class 0.5	Reference
400 A	5 A	2.5 VA	192T 8140				
500 A	5 A	5 VA	192T 8150				
600 A	5 A	5 VA	192T 8160				
750 A	5 A	10 VA	192T 8175	2.5 VA	192T 9675		
800 A	5 A	10 VA	192T 8180	5 VA	192T 9680		
1000 A	5 A	15 VA	192T 8190	10 VA	192T 9690	5 VA	192T 9590
1200 A	5 A	15 VA	192T 8192	10 VA	192T 9692	10 VA	192T 9592
1250 A	5 A	15 VA	192T 8193	15 VA	192T 9693	10 VA	192T 9593
1500 A	5 A	15 VA	192T 8195	15 VA	192T 9695	15 VA	192T 9595
1600 A	5 A	15 VA	192T 8194	15 VA	192T 9694		
2000 A	5 A	15 VA	192T 8196	30 VA	192T 9696	30 VA	192T 9596
2500 A	5 A			30 VA	192T 9697	30 VA	192T 9597
3000 A	5 A			30 VA	192T 9698	30 VA	192T 9598
4000 A	5 A					30 VA	192T 9599

(1) Secondary 1 A: on request.

Accessories

Description of accessories	TCB 44-50 Reference	TCB 44-63 Reference	TCB 55-80 Reference	TCB 85-100 Reference	TCB 100-125 Reference
Sealable cover	192T 0102	192T 0102	192T 0102	192T 0106	192T 0106
CT Plug-in transducer (CEA-VA)	TCB 44-50 Reference	TCB 44-63 Reference	TCB 55-80 Reference		
Power supply					
Output					
Self supplied		192Y 0045	192Y 0045		
230 VAC		192Y 0245	192Y 0245		
24 VDC		192Y 0145	192Y 0145		
CT Plug-in transducer (CEA-VA4)	TCB 44-50 Reference	TCB 44-63 Reference	TCB 55-80 Reference		
Input					
Output					
230 VAC		192Y 0285	192Y 0285		
24 VDC		192Y 0185	192Y 0185		

Bar or cable-through CT

➤ Dimensions

TCB 17-20

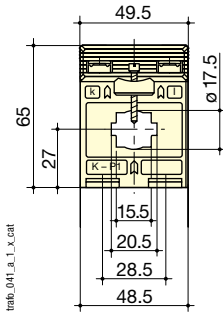

trab_041_a_1_x_cat

TCB 26-30 and T2CB 26-30

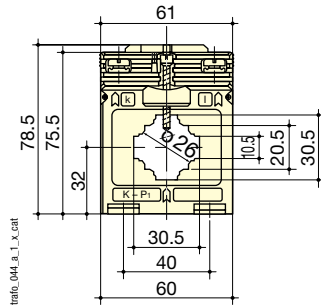

trab_044_a_1_x_cat

TCB 28-30

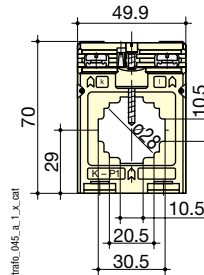

trab_045_a_1_x_cat

TCB 26-40

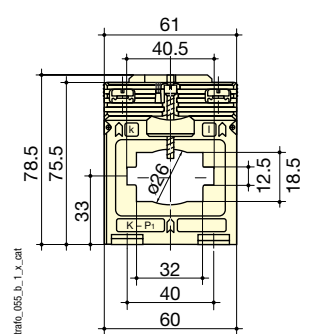

trab_055_b_1_x_cat

TCB 32-40 and T2CB 32-40

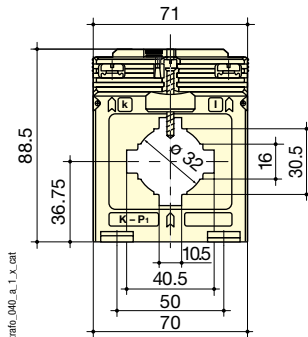

trab_040_a_1_x_cat

TCB 44-50

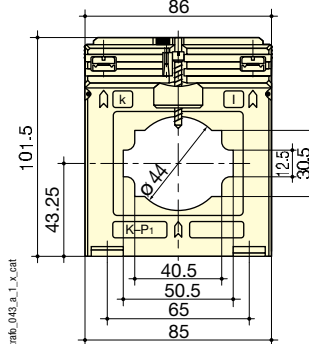

trab_043_a_1_x_cat

TCB 44-63 and T2CB 44-63

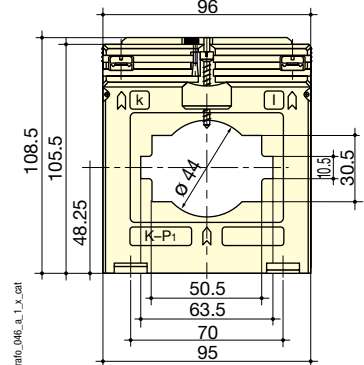

trab_046_a_1_x_cat

TCB 55-80

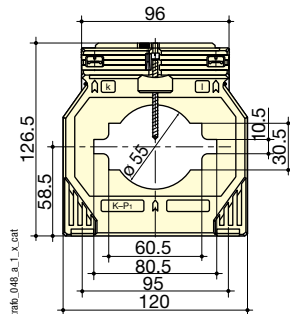

trab_048_a_1_x_cat

TCB 85-100

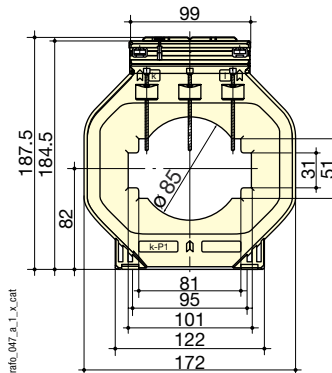

trab_047_a_1_x_cat

TCB 100-125

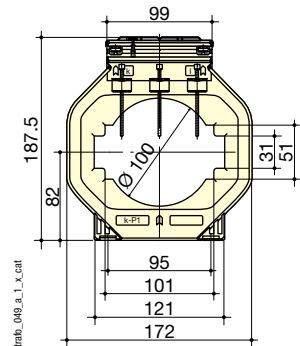

trab_049_a_1_x_cat

Bar or cable-through CT	TCB 17-20	TCB 26-30	T2CB 26-30	TCB 26-40	TCB 28-30	TCB 32-40	T2CB 32-40
Bar (mm)	20 x 5 (x 1)	30 x 10 (x 1) / 20 x 10 (x 1...2)	30 x 10 (x 1) / 20 x 10 (x 1...2)	40 x 12 (x 1) / 32 x 18 (x 1)	30 x 10 (x 1)	40 x 10 (x 1) / 30 x 5 (x 1...2)	40 x 10 (x 1) / 30 x 5 (x 1...2)
Ø cable (mm)	17.5	26	26	26	28	32	32
H x W x D (mm)	65 x 49.5 x 50	78.5 x 61 x 48	78.5 x 61 x 48	78.5 x 61 x 48	70 x 49.9 x 68	88.5 x 71 x 58	88.5 x 71 x 58
DIN rail mounting	yes	yes	yes	yes		yes	yes

Bar or cable-through CT	TCB 44-50	TCB 44-63	T2CB 44-63	TCB 55-80	TCB 85-100	TCB 100-125
Bar (mm)	50 x 12 (x 1) / 40 x 10 (x 1...2)	63 x 10 (x 1) / 50 x 10 (x 1...2)	63 x 10 (x 1) / 50 x 10 (x 1...2)	80 x 10 (x 1) / 60 x 30 (x 1) / 60 x 10 (x 1...2)	100 x 10 (x 1...2) / 80 x 10 (x 1...3)	123 x 30 (x 1) / 100 x 10 (x 1...3)
Ø cable (mm)	44	44	44	55	85	100
H x W x D (mm)	101.5 x 86 x 58	108.5 x 96 x 58	108.5 x 96 x 58	126.5 x 120 x 58	187.5 x 172 x 52	187.5 x 172 x 52

Bar or cable-through CT

➤ Associated transducers



Transducer to be associated with adapted current transformers:

- Class 0.5.
- Input: 1 or 5 A
- Output:
 - 0-20 mA, 0-10 V (type CEA-VA)
 - 4-20 mA, 0-10 V (type CEA-VA4)
- Self-supplied or auxiliary power supply 24 VDC or 230 VAC.
- 3 sizes according to the CT: type 1, 2 or 3.

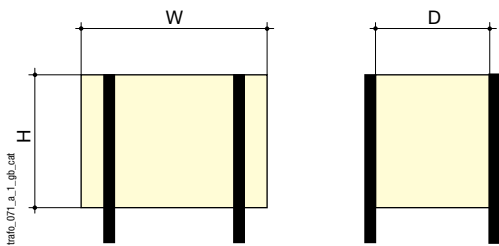
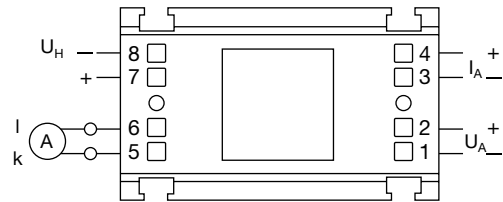

Dimensions (mm)

Transformateur de courant (ASK 205.3) tcb 17-20 75/5a