

Boîtier Doos

- Moulé polyamide 6 (nylon)
- Agrafables : tenons et mortaises
- Hermétiques
- 100 x 100 x H 57 mm

- Gegoten in polyamide 6 (nylon)
- Tap en taggat koppelbaar
- Hermetische
- 100 x 100 x H 57 mm

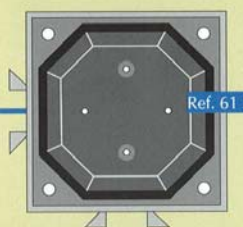
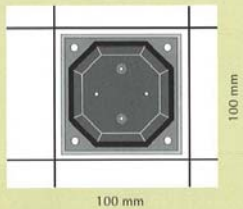
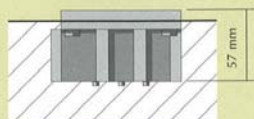

Couvercles Deksels

- Laiton brossé
- Epaisseur : 5 mm
- Geborstelde messing
- Dikte : 5 mm

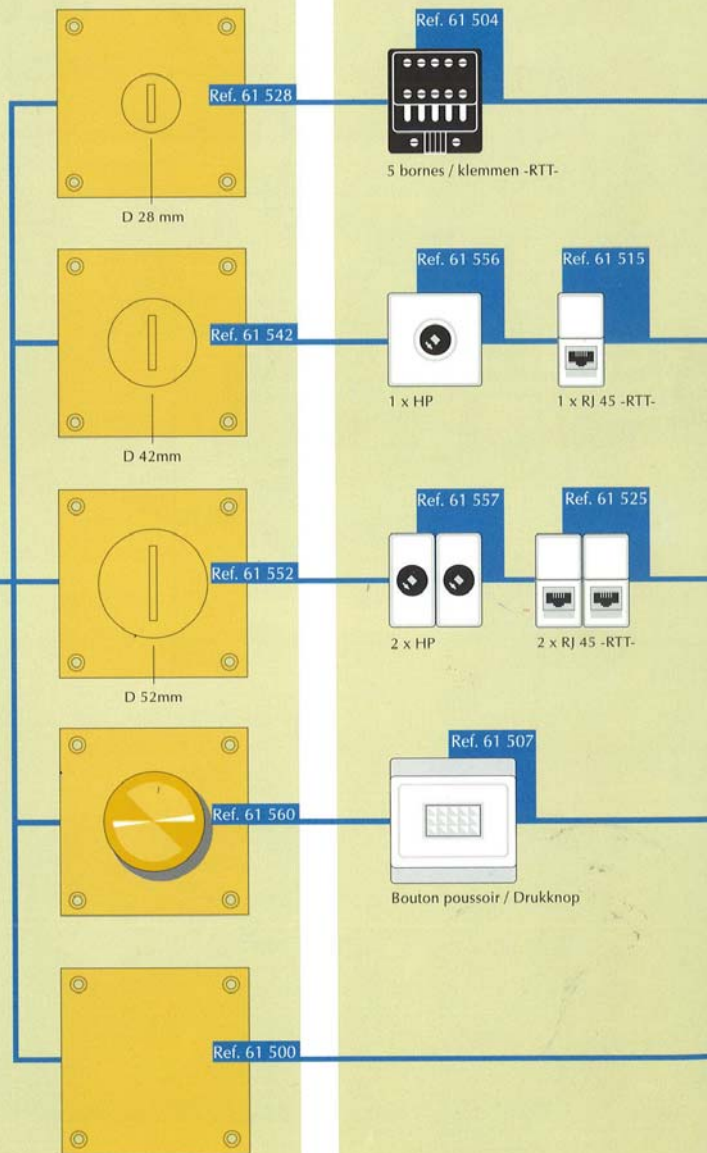

Equipe Uitrustingen

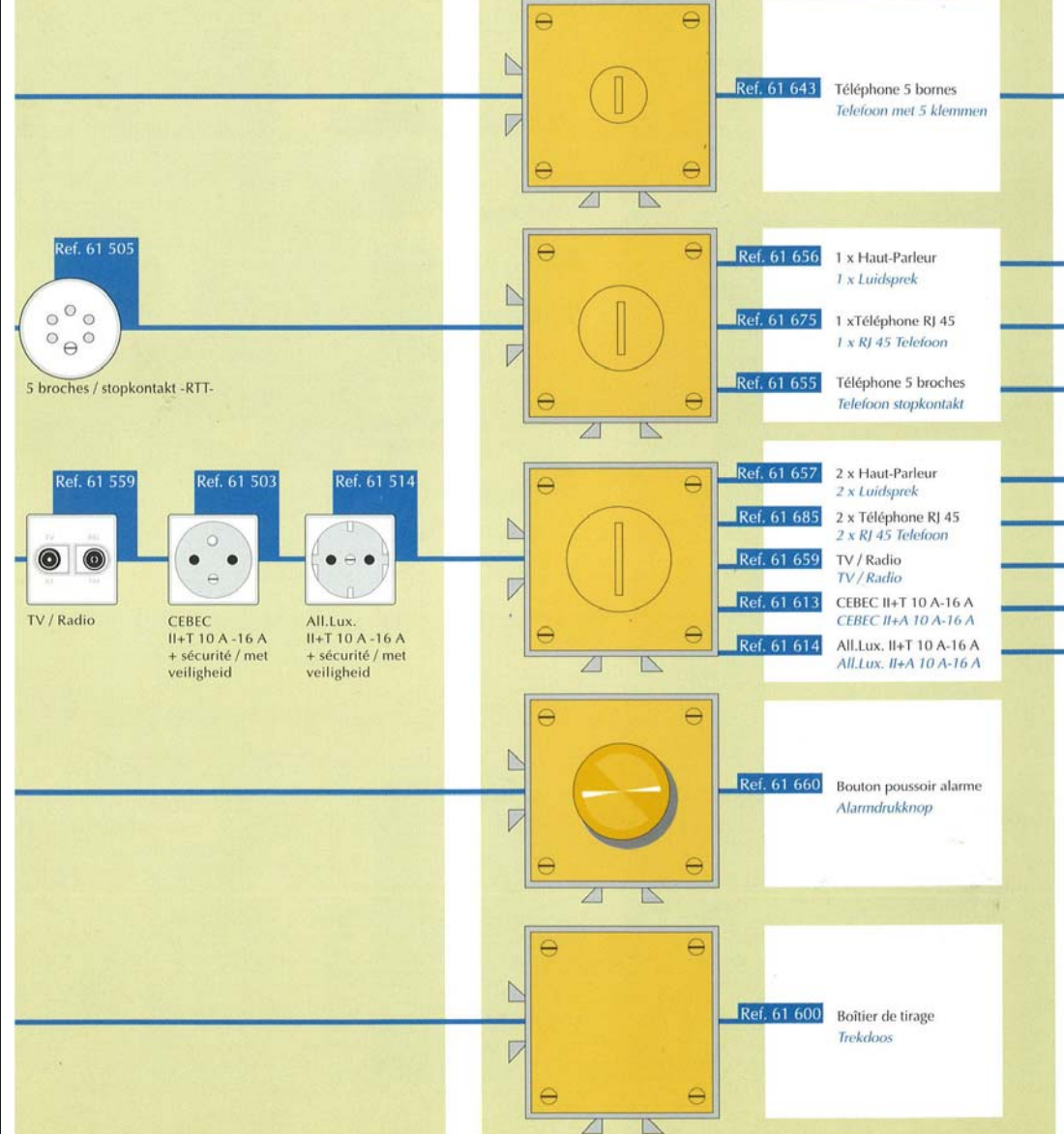

Boîtiers complets Volledige dozen

- Pose niveau fini, utilisations :
- Plaatsing op gelijke hoogte met vloer, gebruik :

Boîtiers complets

Volledige dozen

- Pose niveau fini, utilisations :
- *Plaatsing op gelijke hoogte met vloer, gebruik :*

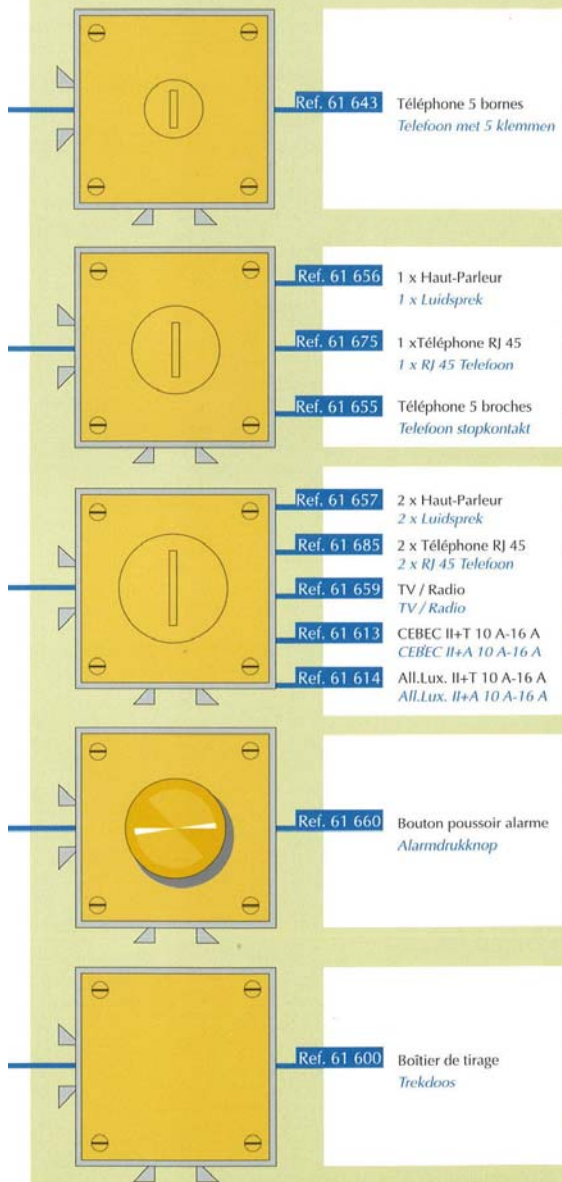

Fiches

Stekkers

- Laiton
- Hermétiques
- Blindées
- A visser
- *Messing*
- *Hermetische*
- *Gepantseerde*
- *Te schroeven*

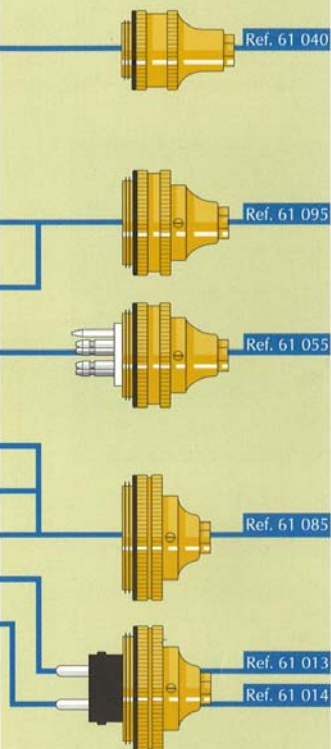

Un boîtier unique
Een enkele doos

avec des équipements multiples
met veelvoudige uitrustingen

- Bouchons en laiton :
Messing karkes :
- Joints en caoutchouc :
Rubber gewrichten :

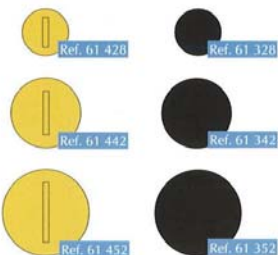

- Nickelage :
Nikkel :
- Visserie :
Schroeven :

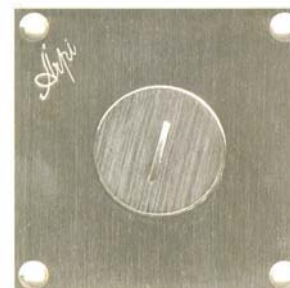

Finition Nickelage brossé pour l'ensemble de la gamme (REF49 998).

Geborstelde nikkel-afwerking op heel het gamma (REF49 998).

Arpi SPRL

Arpi

Arpi

loudorredesign@hotmail.com

contact 0496 50 67 45

REDDESIGN