

Ferrule fuse-links 10x38 aM 400 to 690VAC

LOW VOLTAGE IEC FUSES

IEC CYLINDRICAL FUSE-LINKS



Mersen aM and gG fuse-links cover a wide range of physical sizes and ampere ratings for 400, 500, and 690VAC for protection in electrical distribution circuits and various industrial applications. Most ratings are available in size 8x31 and size 10x38 with an optional indicator, and in size 14x51 and 22x58 with an optional striker to activate an auxiliary contact. Size 10x38 is also available with striker. All cylindrical fuse-links have ceramic bodies and silver-plated contacts.

Cylindrical fuse-links “aM” are partial range fuses. They protect electrical devices in case of unacceptable high short-circuit against destruction due high current limiting and low thermal let-through values. They cut off currents more than $6.3 \times I_n$ until the maximum breaking capacity (rated breaking capacity). Cylindrical fuse-links “aM” are mainly used for the protection of installation switch gear in motor circuit currents. For classification of the cylindrical fuse-links the nominal current of the fuse-link can be selected respective to the nominal current of the motor.

Our technology and process was designed to ensure highly reliable technical performance.

TECHNICAL DATA OVERVIEW

Voltage Range AC	400 ... 690 VAC
Ampere Range (A)	0.16 ... 32 A
Speed/Characteristic	aM
I.R. AC (IEC)	120 kA
Body Material	Ceramic
Body Style	cylindrical
Contact Materials	Silver plated copper
Product Size	10x38 mm

FEATURES & BENEFITS

- Reduced size
- Visual indication of fuse operation
- Safest and most reliable protection system
- Optional indicator

APPLICATIONS

- aM type for protection of motors, transformers and other loads with in-rush currents.

STANDARDS

- IEC 60269-1 & -2 (electrically only for the range with striker)
- Approved by various shipping organizations



Ferrule fuse-links 10x38 aM 400 to 690VAC

PRODUCT RANGE

Size 10,3x38 aM 400/500VAC without indicator



FR10AM40V32

Catalog number	Item number	Rated voltage AC (IEC)	Rated current I _n	Rated breaking capacity AC	Power dissipation at I _n	Weight
FR10AM50V0.16	E214617	500 V	0.16 A	120 kA	0.07 W	8.3 g
FR10AM50V0.25	M215130	500 V	0.25 A	120 kA	0.08 W	8.3 g
FR10AM50V0.5	W216150	500 V	0.5 A	120 kA	0.07 W	8.3 g
FR10AM50V1	F217171	500 V	1 A	120 kA	0.1 W	8.3 g
FR10AM50V2	H218714	500 V	2 A	120 kA	0.14 W	8.3 g
FR10AM50V4	W219232	500 V	4 A	120 kA	0.28 W	8.3 g
FR10AM50V6	F222208	500 V	6 A	120 kA	0.38 W	8.3 g
FR10AM50V8	Z201295	500 V	8 A	120 kA	0.55 W	8.3 g
FR10AM50V10	Y211552	500 V	10 A	120 kA	0.62 W	8.3 g
FR10AM50V12	A213601	500 V	12 A	120 kA	0.82 W	8.3 g
FR10AM50V16	F214618	500 V	16 A	120 kA	0.87 W	8.3 g
FR10AM50V20	X216151	500 V	20 A	120 kA	1.05 W	8.3 g
FR10AM40V25	G217172	400 V	25 A	120 kA	1.2 W	8.3 g
FR10AM40V32	J218715	400 V	32 A	120 kA	1.8 W	8.3 g

Size 10,3x38 aM 400/500VAC with indicator



FR10AM50V10I

Catalog number	Item number	Rated voltage AC (IEC)	Rated current I _n	Rated breaking capacity AC	Power dissipation at I _n	Weight
FR10AM50V1I	X219233	500 V	1 A	120 kA	0.1 W	8.3 g
FR10AM50V2I	G222209	500 V	2 A	120 kA	0.14 W	8.3 g
FR10AM50V4I	K200753	500 V	4 A	120 kA	0.28 W	8.3 g
FR10AM50V6I	K201811	500 V	6 A	120 kA	0.38 W	8.3 g
FR10AM50V8I	Z211553	500 V	8 A	120 kA	0.55 W	8.3 g
FR10AM50V10I	H213102	500 V	10 A	120 kA	0.62 W	8.3 g
FR10AM50V12I	D214110	500 V	12 A	120 kA	0.82 W	8.3 g
FR10AM50V16I	P215132	500 V	16 A	120 kA	0.87 W	8.3 g
FR10AM50V20I	V216655	500 V	20 A	120 kA	1.05 W	8.3 g
FR10AM40V25I	L217682	400 V	25 A	120 kA	1.2 W	8.3 g

Size 10,3x38 aM 400VAC with striker



FR10AM40V16P

Catalog number	Item number	Rated voltage AC (IEC)	Rated current I _n	Rated breaking capacity AC	Power dissipation at I _n	Weight
FR10AM40V2P	Z084984	400 V	2 A	100 kA	0.18 W	9.2 g
FR10AM40V4P	Y085259	400 V	4 A	100 kA	0.2 W	9.2 g
FR10AM40V6P	W085257	400 V	6 A	100 kA	0.21 W	9.2 g
FR10AM40V8P	A084985	400 V	8 A	100 kA	0.29 W	9.2 g
FR10AM40V10P	B084986	400 V	10 A	100 kA	0.36 W	9.2 g
FR10AM40V12P	X085258	400 V	12 A	100 kA	0.43 W	9.2 g
FR10AM40V16P	C084757	380 V	16 A	100 kA	0.57 W	9.2 g
FR10AM40V20P	V085256	380 V	20 A	100 kA	0.72 W	9.2 g
FR10AM25V25P	A076038	250 V	25 A	100 kA	1.2 W	9.2 g
FR10AM25V32P	B076039	250 V	32 A	100 kA	1.6 W	9.2 g

MERSEN reserves the right to change, update or correct, without notice, any information contained in this datasheet.

Ferrule fuse-links 10x38 aM 400 to 690VAC

PRODUCT RANGE



FR10AM69V10

Size 10,3x38 aM 690VAC without indicator

Catalog number	Item number	Rated voltage AC (IEC)	Rated current I_n	Rated breaking capacity AC	Power dissipation at I_n	Weight
FR10AM69V1	H302779	690 V	1 A	120 kA	0.1 W	8.3 g
FR10AM69V2	J302780	690 V	2 A	120 kA	0.14 W	8.3 g
FR10AM69V4	K302781	690 V	4 A	120 kA	0.28 W	8.3 g
FR10AM69V6	L302782	690 V	6 A	120 kA	0.38 W	8.3 g
FR10AM69V8	M302783	690 V	8 A	120 kA	0.55 W	8.3 g
FR10AM69V10	N302784	690 V	10 A	120 kA	0.62 W	8.3 g
FR10AM69V12	P302785	690 V	12 A	120 kA	0.78 W	8.3 g

Ferrule fuse-links 10x38 aM 400 to 690VAC

TIME CURRENT CHARACTERISTIC CURVES

Size 10x38 500V aM without striker

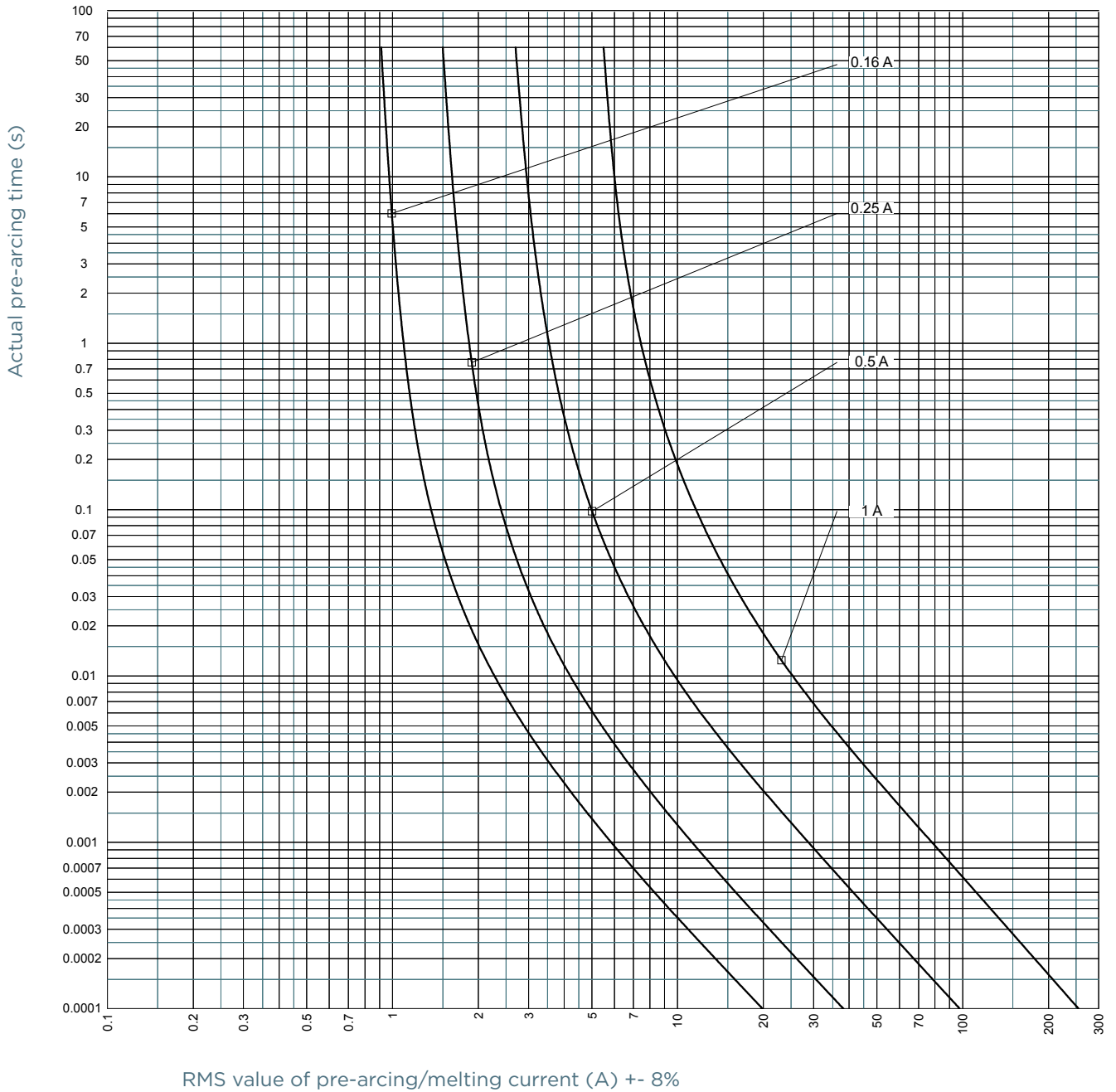

MERSEN reserves the right to change, update or correct, without notice, any information contained in this datasheet.

Ferrule fuse-links 10x38 aM 400 to 690VAC

TIME CURRENT CHARACTERISTIC CURVES

Size 10x38 500V aM without striker

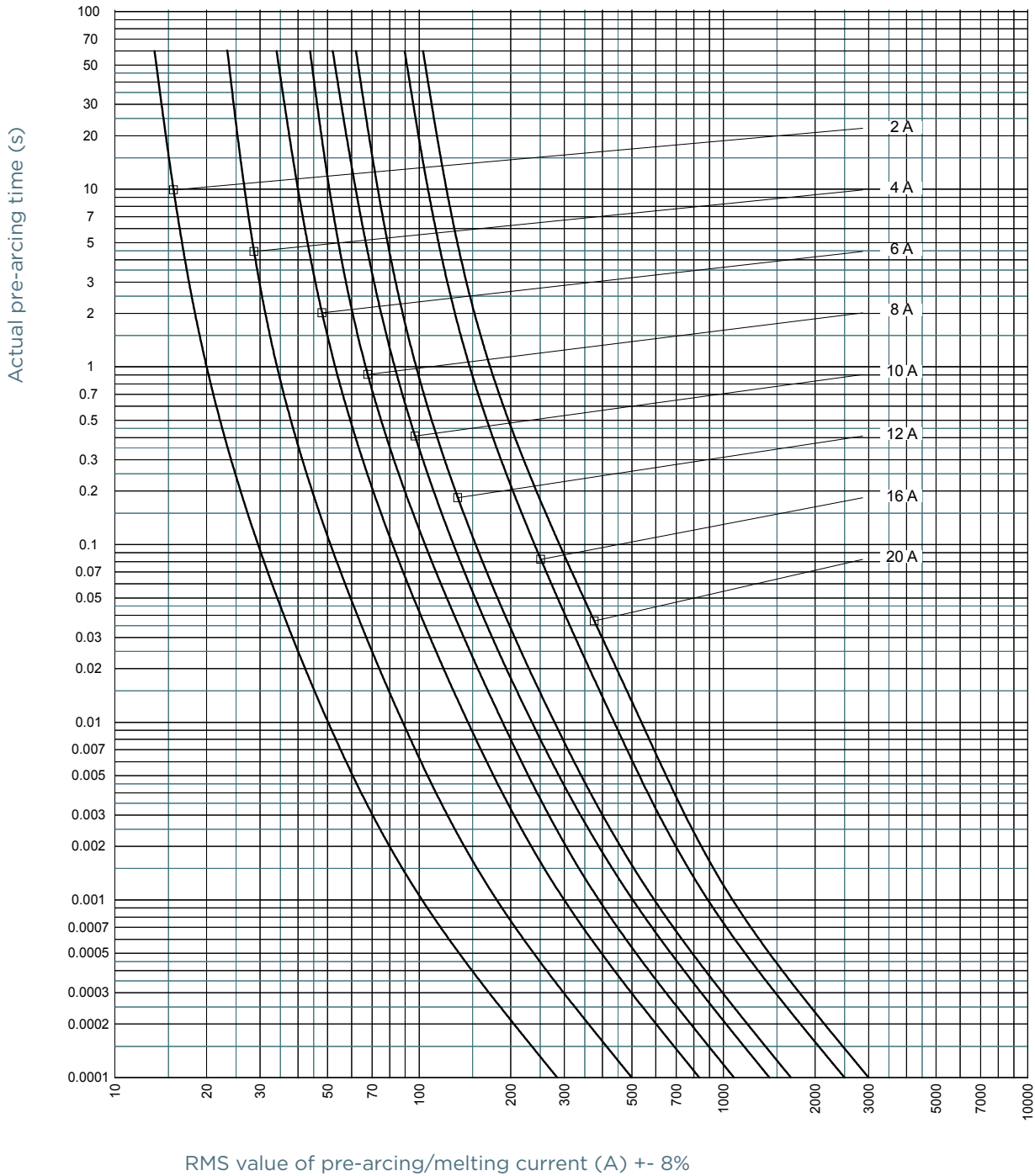

MERSEN reserves the right to change, update or correct, without notice, any information contained in this datasheet.

Ferrule fuse-links 10x38 aM 400 to 690VAC

TIME CURRENT CHARACTERISTIC CURVES

Size 10x38 400V aM without striker

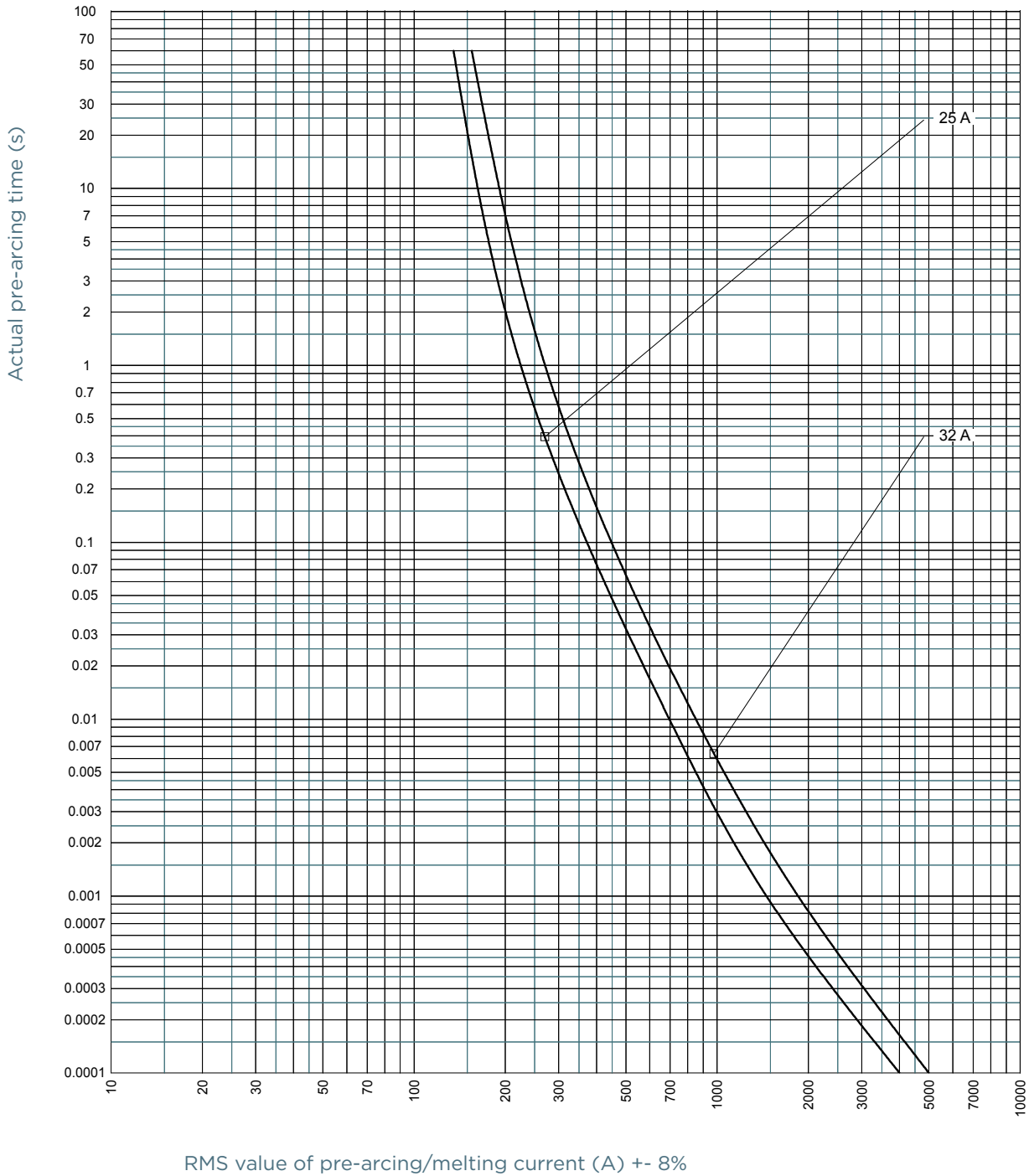

MERSEN reserves the right to change, update or correct, without notice, any information contained in this datasheet.

Ferrule fuse-links 10x38 aM 400 to 690VAC

TIME CURRENT CHARACTERISTIC CURVES

Size 10x38 690V aM without striker

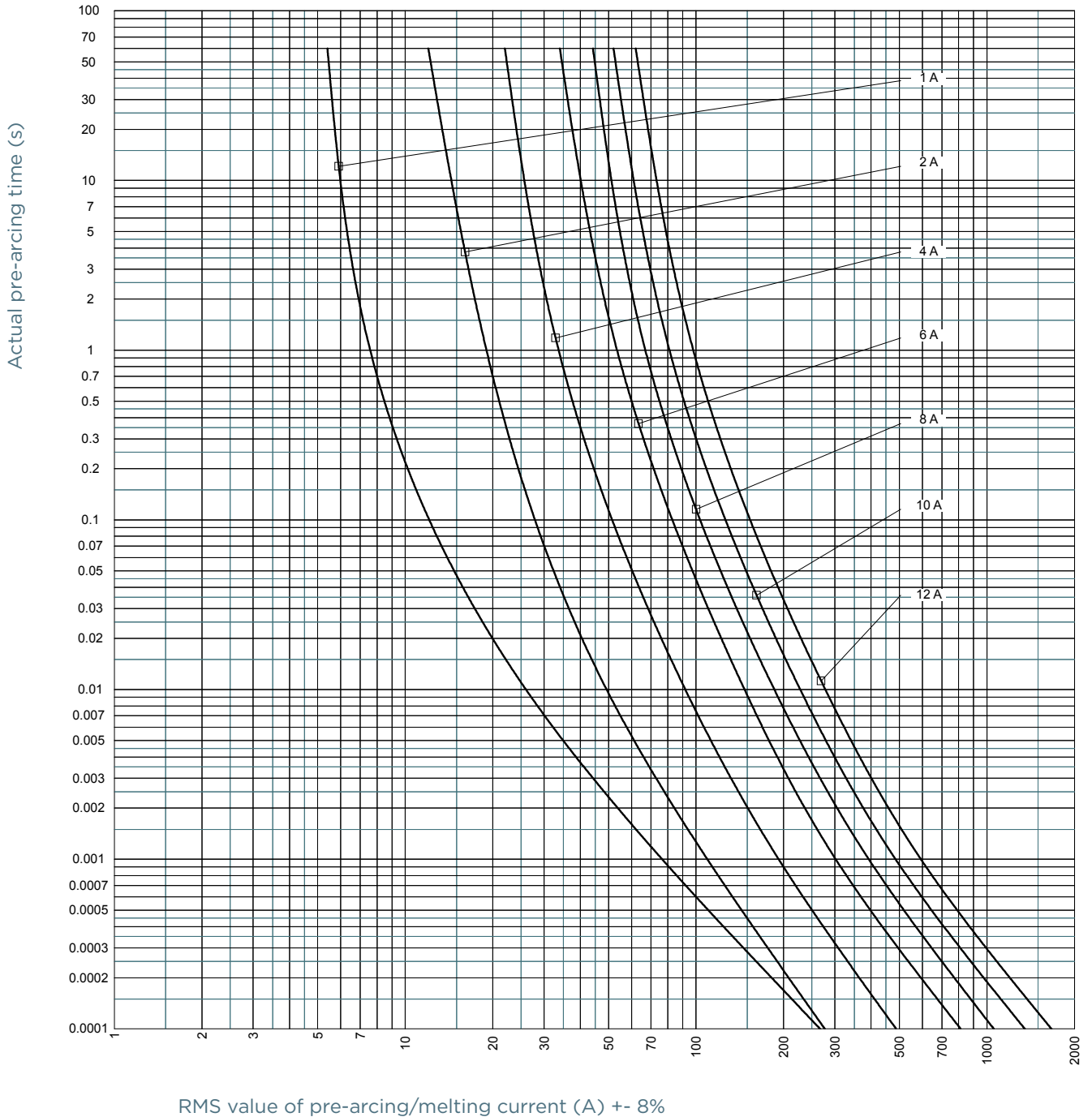

MERSEN reserves the right to change, update or correct, without notice, any information contained in this datasheet.

Ferrule fuse-links 10x38 aM 400 to 690VAC

TIME CURRENT CHARACTERISTIC CURVES

Size 10x38 400V aM with striker

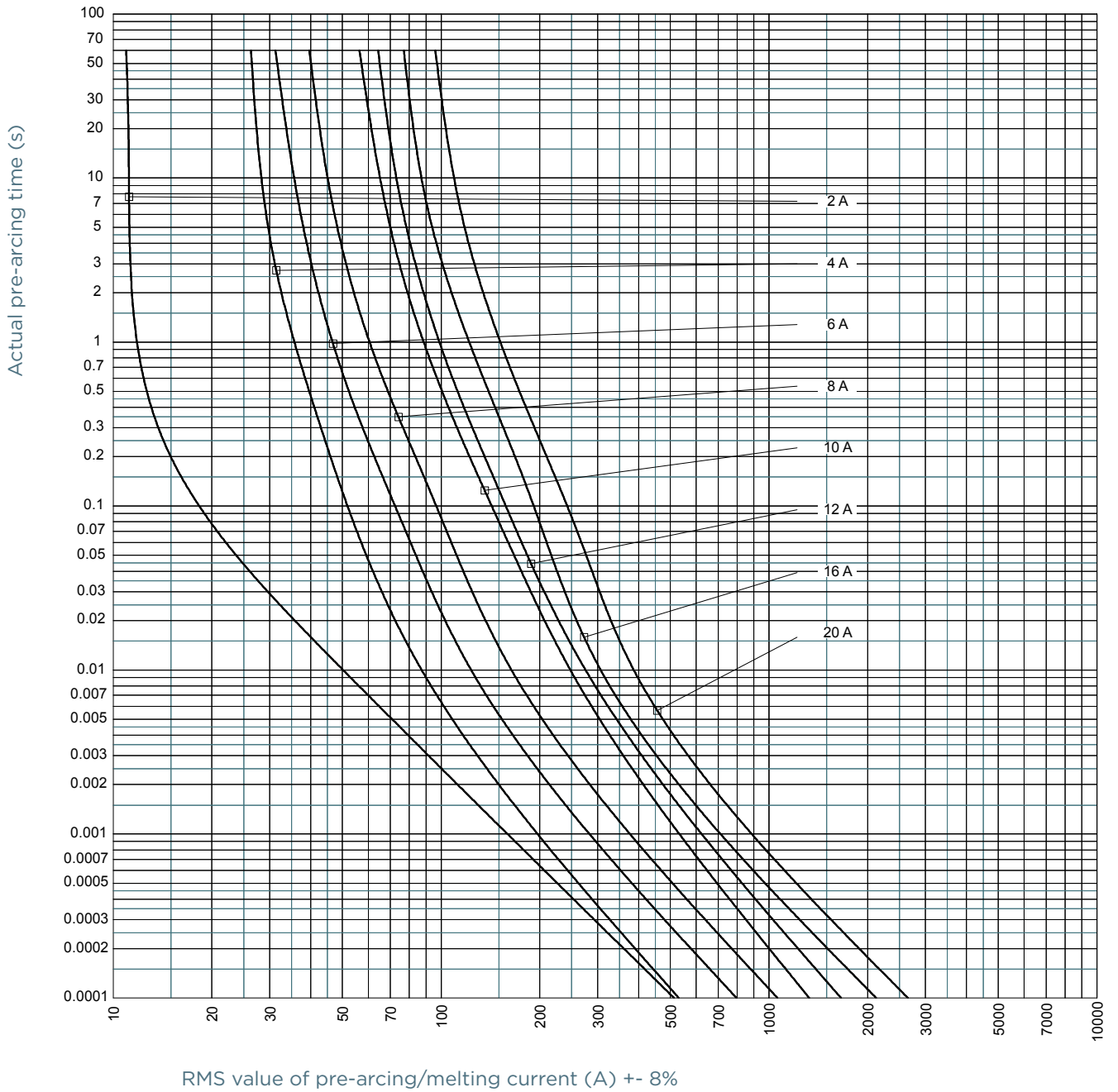

MERSEN reserves the right to change, update or correct, without notice, any information contained in this datasheet.

Ferrule fuse-links 10x38 aM 400 to 690VAC

TIME CURRENT CHARACTERISTIC CURVES

Size 10x38 250V aM with striker

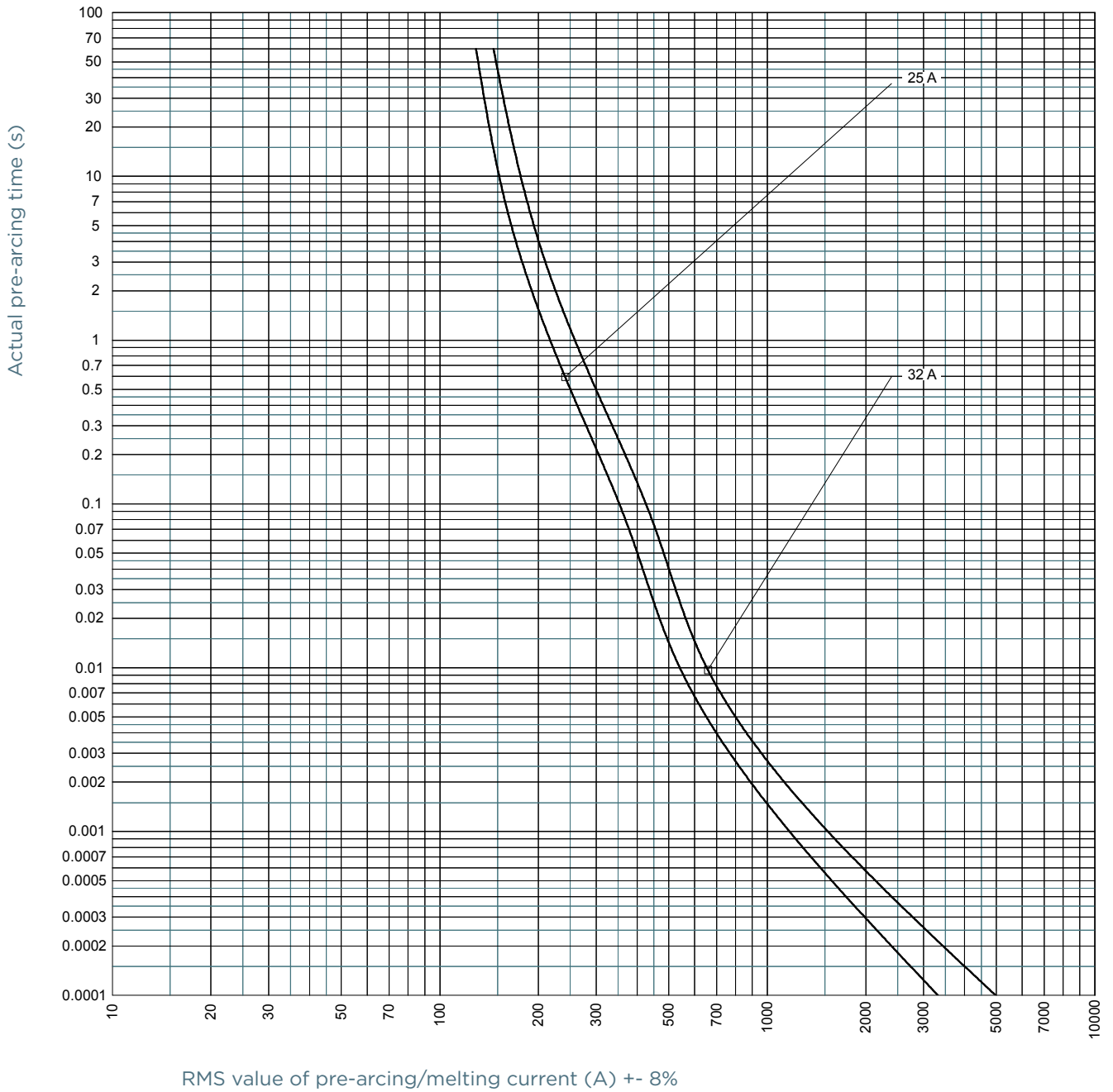

MERSEN reserves the right to change, update or correct, without notice, any information contained in this datasheet.

Ferrule fuse-links 10x38 aM 400 to 690VAC

CUT-OFF CURRENT CHARACTERISTIC

Size 10x38 500V aM without striker

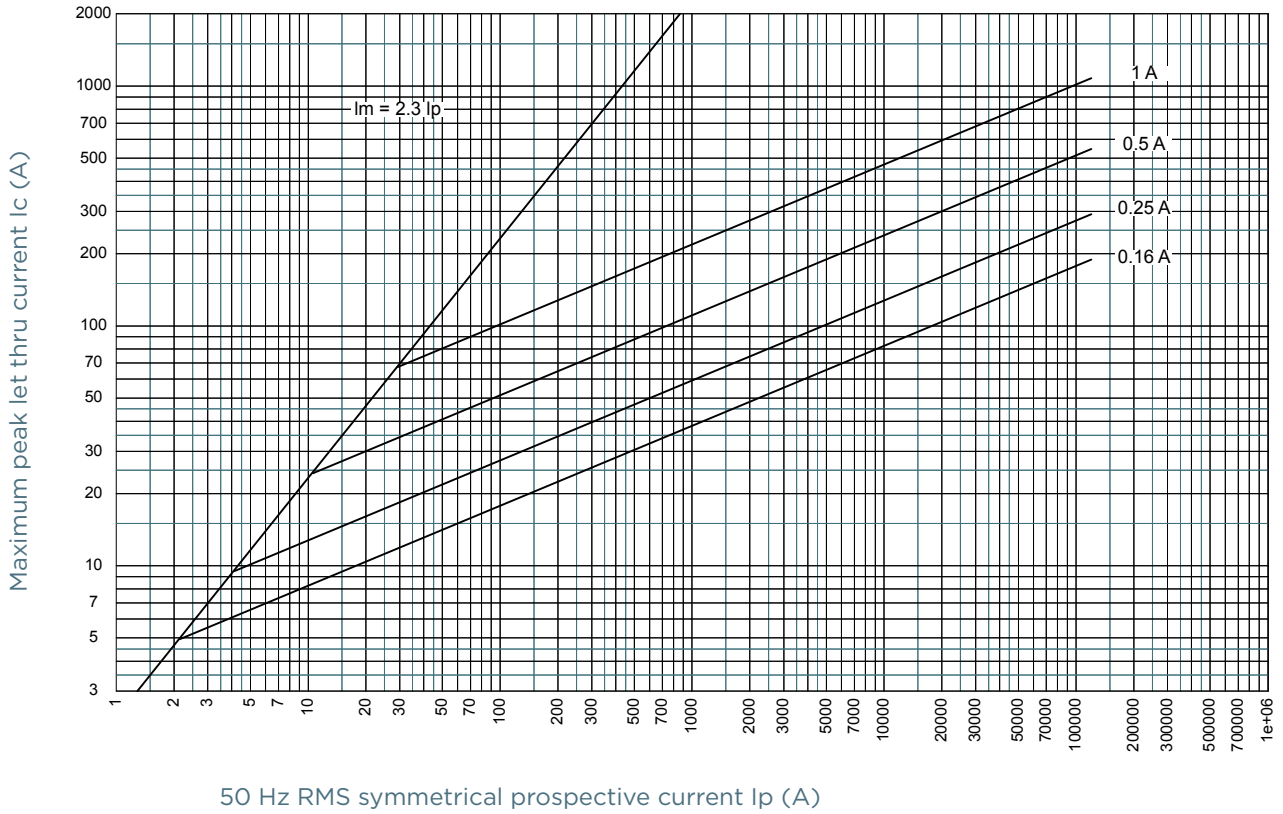

MERSEN reserves the right to change, update or correct, without notice, any information contained in this datasheet.

Ferrule fuse-links 10x38 aM 400 to 690VAC

CUT-OFF CURRENT CHARACTERISTIC

Size 10x38 500V aM without striker

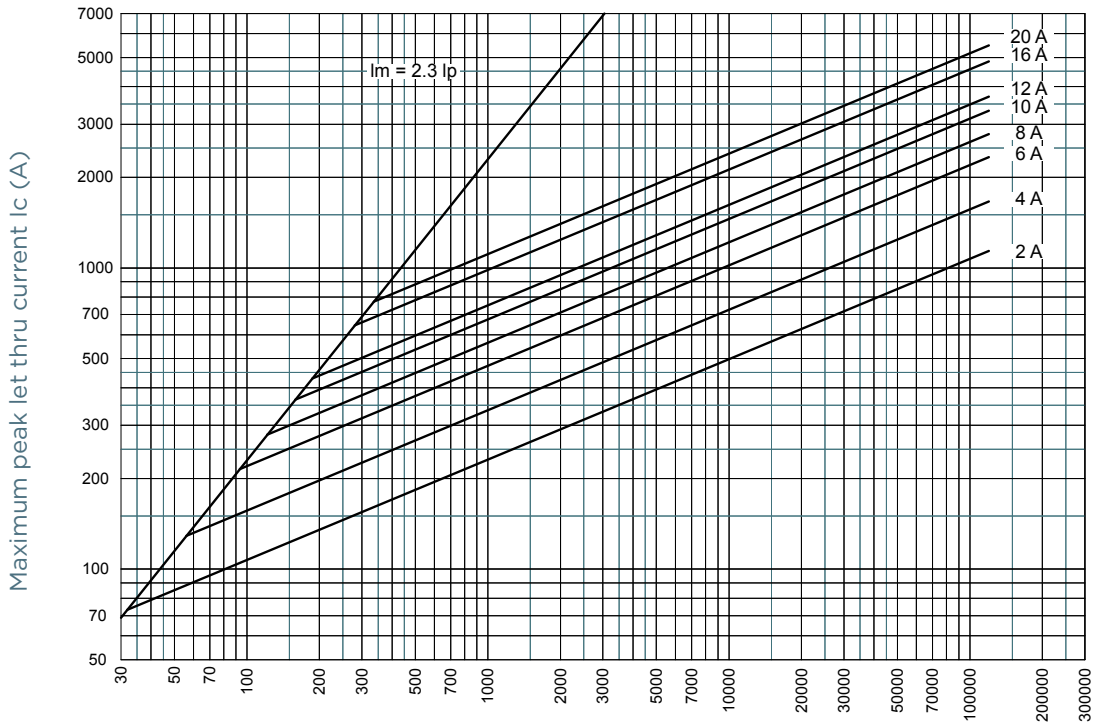

50 Hz RMS symmetrical prospective current I_p (A)

Size 10x38 400V aM without striker

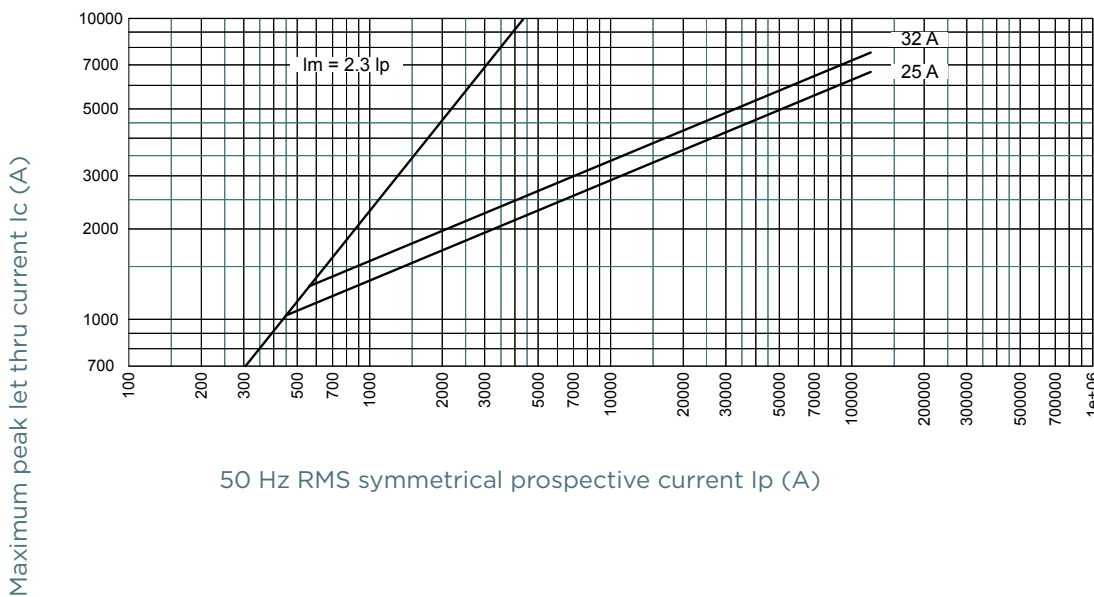

50 Hz RMS symmetrical prospective current I_p (A)

MERSEN reserves the right to change, update or correct, without notice, any information contained in this datasheet.

Ferrule fuse-links 10x38 aM 400 to 690VAC

CUT-OFF CURRENT CHARACTERISTIC

Size 10x38 690V aM without striker

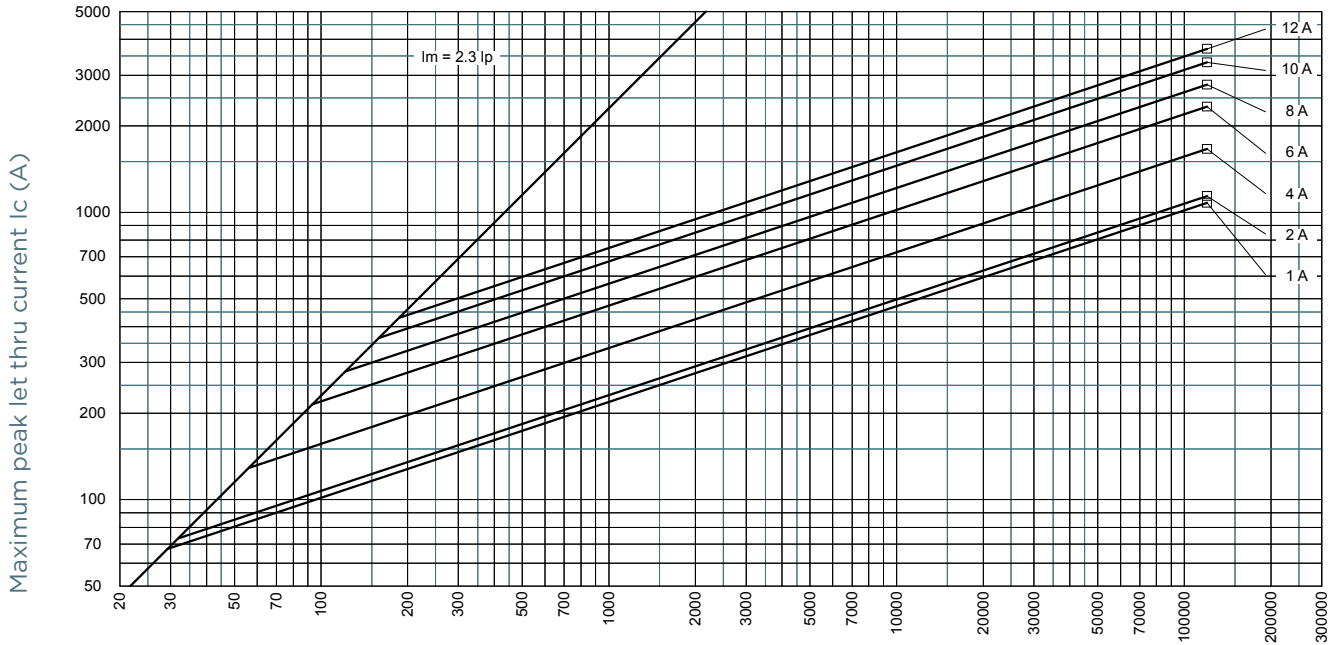

Size 10x38 400V aM with striker
50 Hz RMS symmetrical prospective current I_p (A)

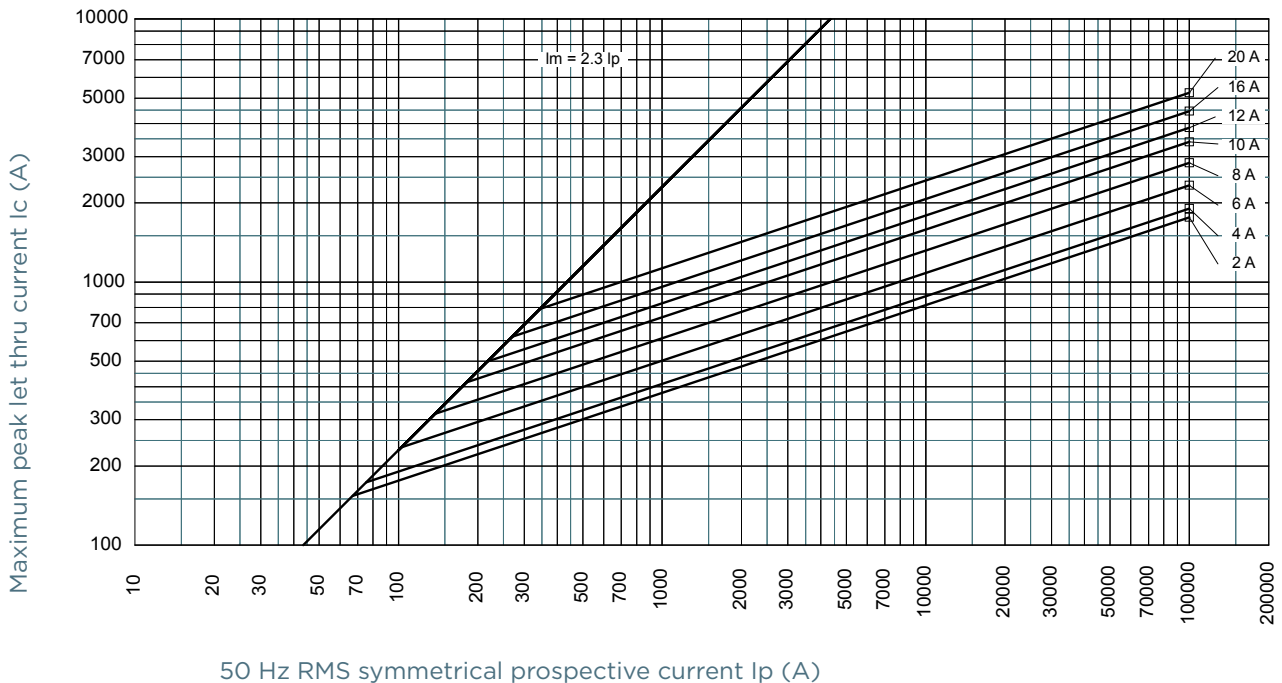

MERSEN reserves the right to change, update or correct, without notice, any information contained in this datasheet.

Ferrule fuse-links 10x38 aM 400 to 690VAC

CUT-OFF CURRENT CHARACTERISTIC

Size 10x38 250V aM with striker

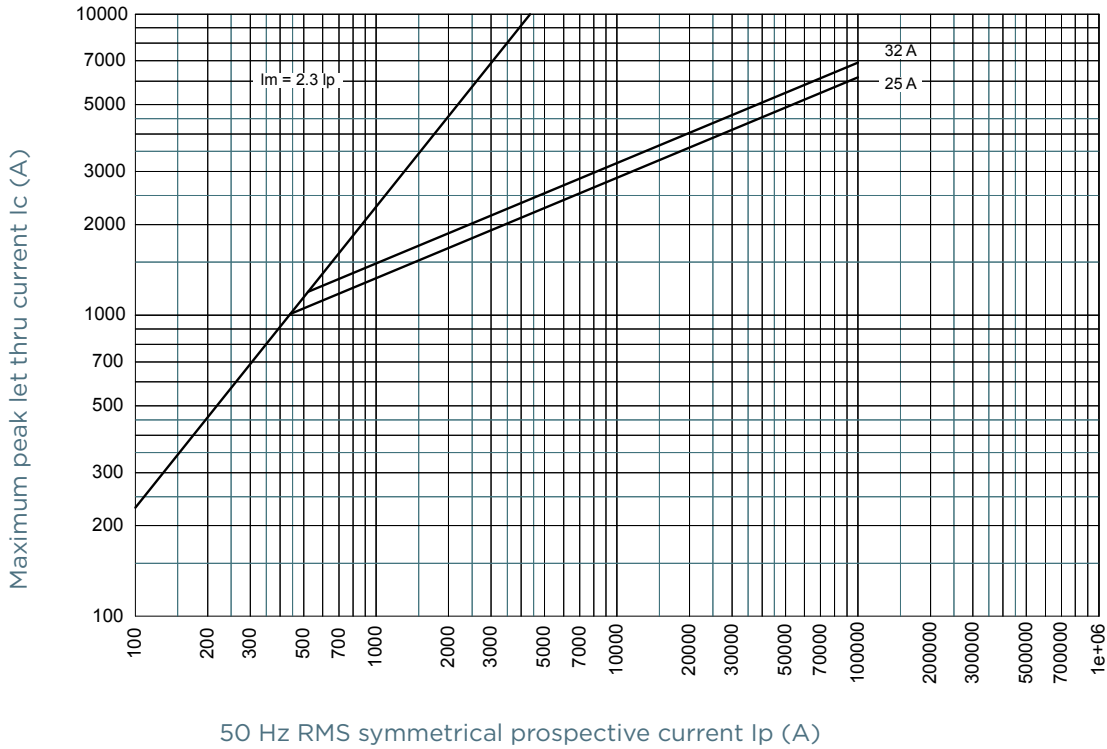

PRE-ARCING AND OPERATING I^2t CHARACTERISTICS

Size 10x38 500V aM without striker

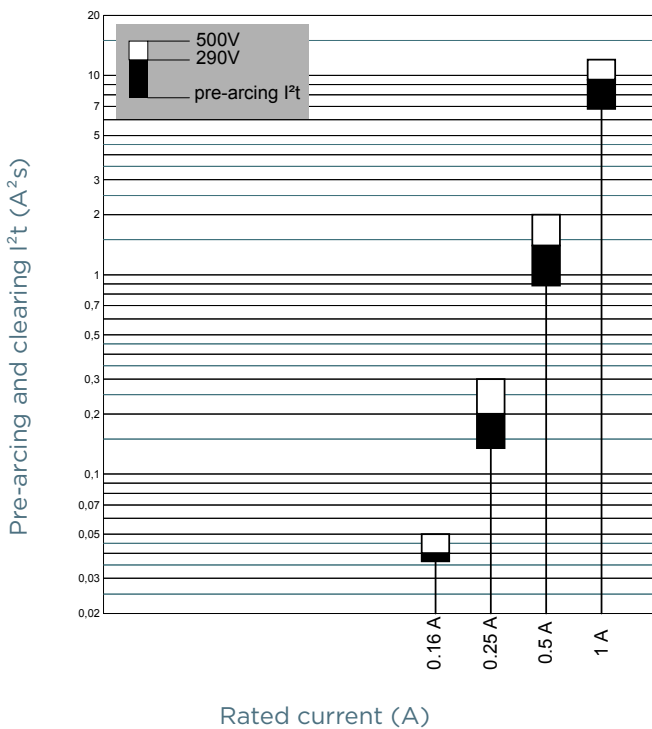

Ferrule fuse-links 10x38 aM 400 to 690VAC

PRE-ARCING AND OPERATING I²t CHARACTERISTICS

Size 10x38 500V aM without striker

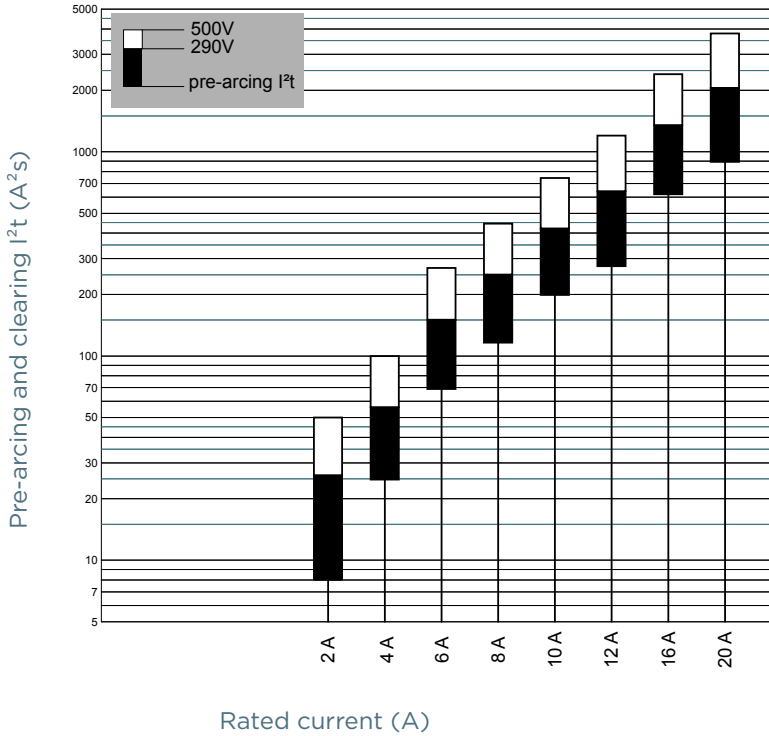

Size 10x38 400V aM without striker

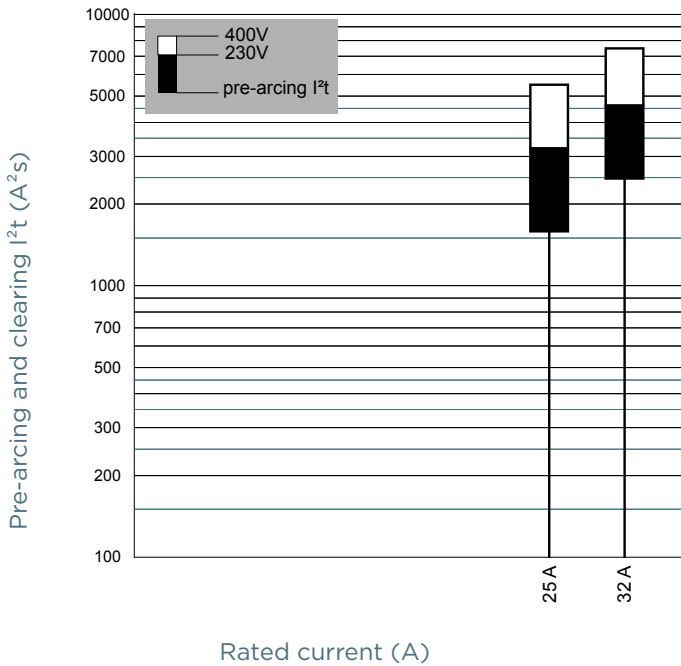

MERSEN reserves the right to change, update or correct, without notice, any information contained in this datasheet.

Ferrule fuse-links 10x38 aM 400 to 690VAC

PRE-ARCING AND OPERATING I²T CHARACTERISTICS

Size 10x38 690V aM without striker

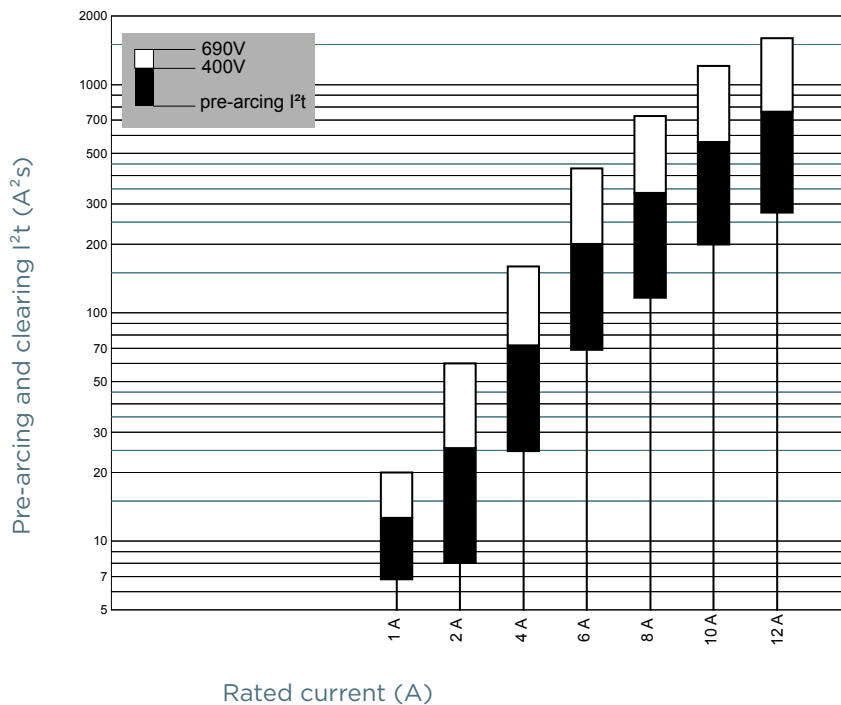

Ferrule fuse-links 10x38 aM 400 to 690VAC

PRE-ARCING AND OPERATING I²t CHARACTERISTICS

Size 10x38 400V aM with striker

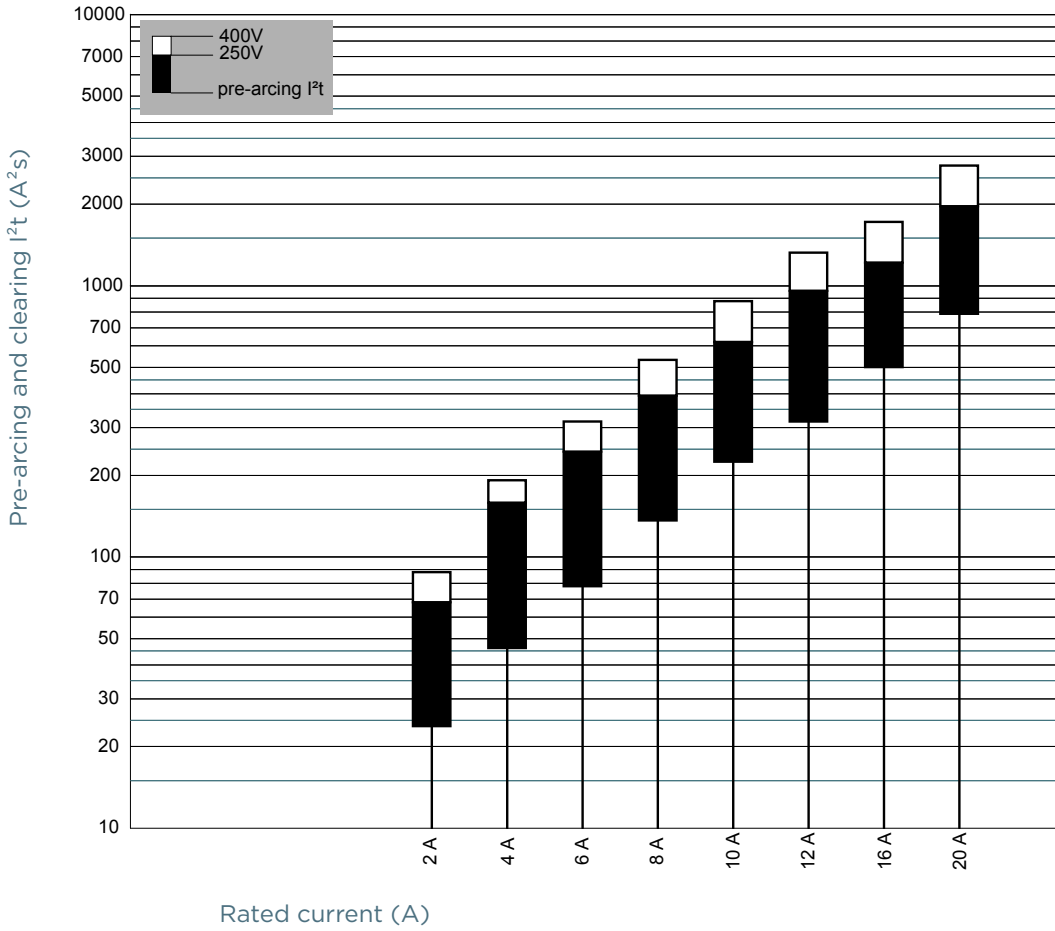

Size 10x38 250V aM with striker

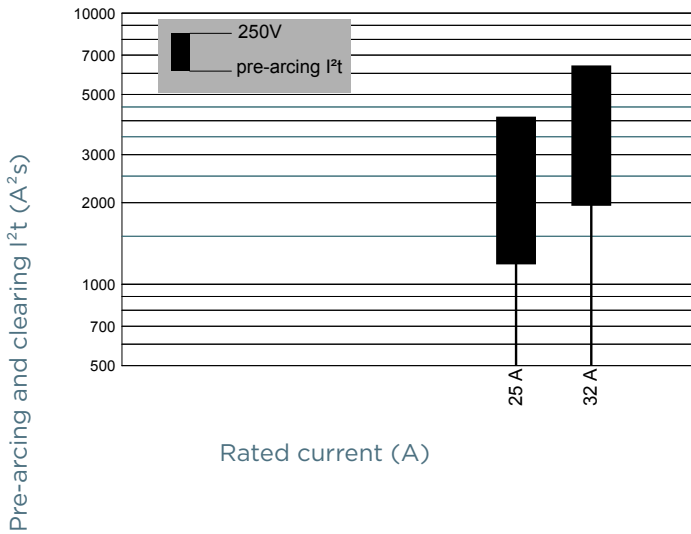

MERSEN reserves the right to change, update or correct, without notice, any information contained in this datasheet.

Ferrule fuse-links 10x38 aM 400 to 690VAC

DIMENSIONS

Size 10x38 aM without indicator (1001210)

Size 10x38 aM with indicator (1002537)

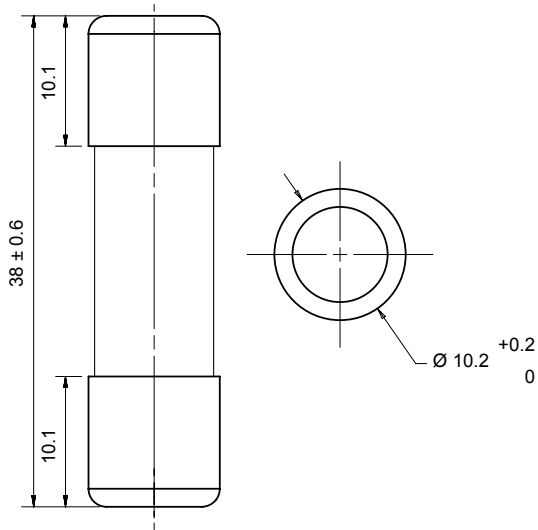

Dimensions in mm

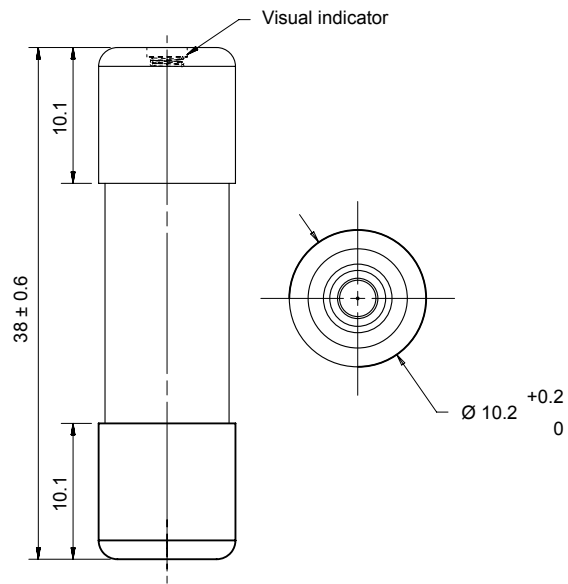

Dimensions in mm

Size 10x38 aM with striker (33907)

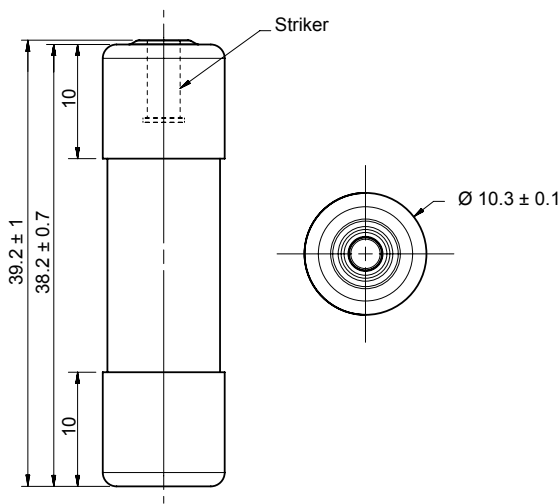

Dimensions in mm