

**Accessories- tie bases SES®**  
for cable ties SL - SE - SR  
and SM lashing ties



SES®



**• Wall plug**

The tie bases with wall plug in polyamide, black colour, are designed to be used with our cable ties for installation series SM width 90 mm. It is recommended to use the tie bases in PA6 for an interior use and the tie bases in PA12 for an external use.

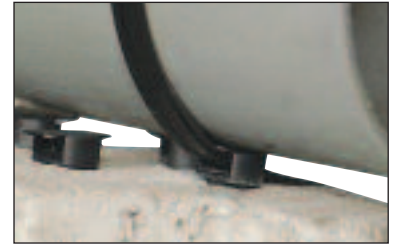

type	article number		material	cable ties section max.	Ø bore mm	bore depth mm
<b>Mounting with tool</b>						
CH-934- 6	0189 0526 010	100	PA 6	2,4 x 10	8	41
CH-934-12	0189 0525 010	100	PA12	2,4 x 10	8	41
CH-944- 6	0189 0540 010	100	PA 6	2,5 x 10	8	38
CH-944-12	0189 0530 010	100	PA12	2,5 x 10	8	38

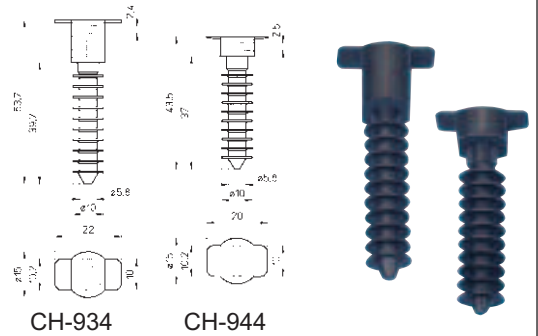

**Manual mounting**

CH-937- 6	0189 0541 010	100	PA 6	2,4 x 10	8	40
CH-937-12	0189 0542 010	100	PA12	2,4 x 10	8	40
CH-947- 6	0189 0543 010	100	PA 6	2,5 x 10	8	40
CH-947-12	0189 0544 010	100	PA12	2,5 x 10	8	40

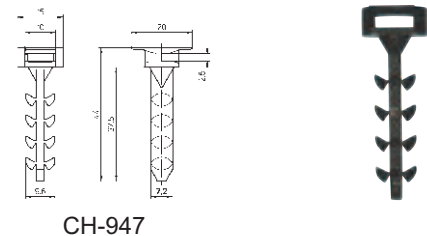
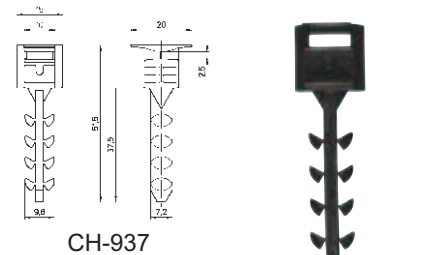
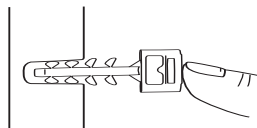

**• CH-935 wall plug with cradle in black PA 6 and PA 12**

in black PA 6		100	wall plug for ties of max. section 3 x 9,6 mm fixing by screw TF 5 mm
CH-935-6	0189 0536 010		
in black PA 12		100	
CH-935-12	0189 0535 010		

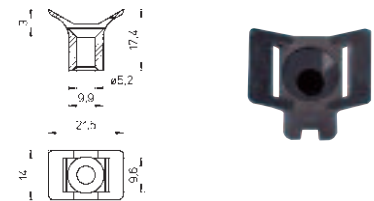

**• CH-936 double wall plug in black PA 6 and PA 12**

in black PA 6		100	double wall plug for 2 ties of max. passing section 4,4 x 9,6 mm
CH-936-6	0189 0516 010		
in black PA 12		100	
CH-936-12	0189 0515 010		

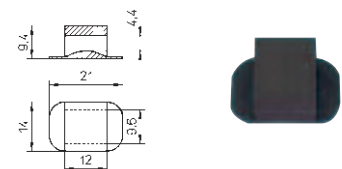

Embase cheville CH-944-PA12

