

Date

Name

Client

Project Name

Quote#

Type/Quantity

DIRO TRIMLESS LED 92733

202 144 811 922

[Lien web](#)

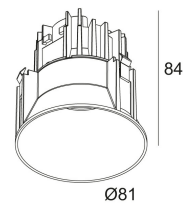
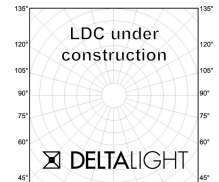

Forme/taille découpée: Ø KIT mm

Profondeur 95 mm

d'encastrement:

Coloris disponibles: NOIR (202 144 811 922 B)
BLANC (202 144 811 922 W)
OR MAT (202 144 811 922 MMAT)

NON ADJUSTABLE

INCL.1 x LED WHITE 7,1-10,4W / CRI>90 / 2700K / max.1032lm

INCL.1 x REFLECTOR FL-33°

EXCL.LED POWER SUPPLY 350-500mA-DC

ON REQUEST : CRI > 95

Technics LED: Source lumineuse: 1032 lm // 10 W // 105 lm/W
Luminaire: 12 W

Classe: III

Poids: 0.3 KG

Niveau de protection: IP23/20

Distance minimale: indisponible.

Options: LED POWER SUPPLY 350 / 500mA-DC DIM

Exigences: MOUNTING KIT R82 TRIMLESS O.F.A.

Pour obtenir des instructions d'installation détaillées, Consultez le manuel svp

[202_144_811_XXX_HAND.pdf](#)

DIRO TRIMLESS LED 92733

202 144 811 922

La compatibilité du plafond

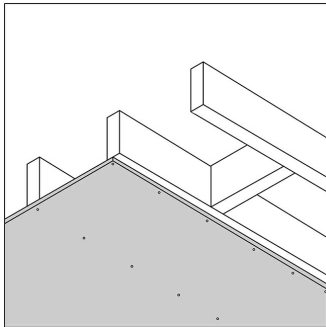

Placoplâtre / BA13

Seulement avec

MOUNTING KIT R82
TRIMLESS O.F.A.

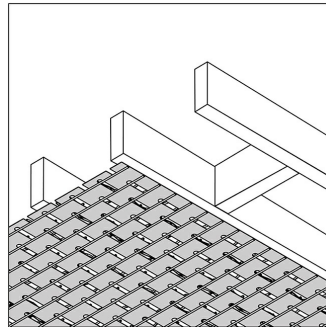

Stucanet

Seulement avec

MOUNTING KIT R82
TRIMLESS O.F.A.

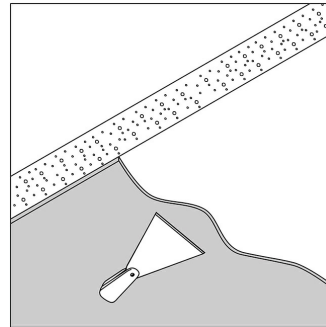

Béton + plâtre

Seulement avec

MOUNTING KIT R82
TRIMLESS O.F.A.

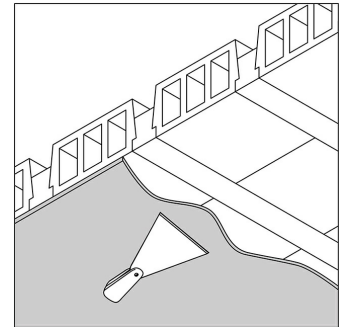

Hourdis béton + plâtre

Seulement avec

MOUNTING KIT R82
TRIMLESS O.F.A.

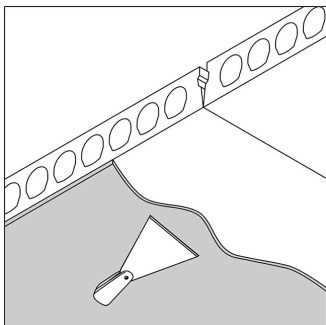

**Dalle béton
préfabriqué + plâtre**

Seulement avec

MOUNTING KIT R82
TRIMLESS O.F.A.

[Lien web / Fiche techn.](#)

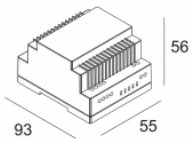

LED POWER CONVERTOR 24V-DC TO MULTI CURRENT 48W DIMS
300 90 67
Nombre de luminaires: 2 / - / -

[Lien web / Fiche techn.](#)

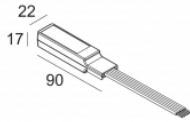

LED POWER CONVERTOR 48V-DC to 350 mA-DC / 15W DIM1
300 48 350 ED1
Nombre de luminaires: 1

[Lien web / Fiche techn.](#)

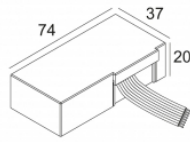

LED POWER CONVERTOR 48V-DC to 350 mA-DC / 15W DIM5
300 48 350 ED5
Nombre de luminaires: 1

[Lien web / Fiche techn.](#)

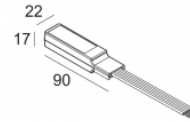

LED POWER CONVERTOR 48V-DC to 350 mA-DC / 15W MDL
300 48 350 MDL
Nombre de luminaires: 1

[Lien web / Fiche techn.](#)

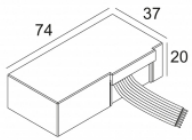

LED POWER CONVERTOR 48V-DC to 350 mA-DC / 15W WDL
300 48 350 WDL
Nombre de luminaires: 1

[Lien web / Fiche techn.](#)

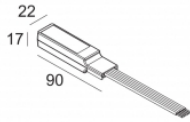

LED POWER CONVERTOR 48V-DC to 500 mA-DC / 22W DIM1
300 48 500 ED1
Nombre de luminaires: 1

[Lien web / Fiche techn.](#)

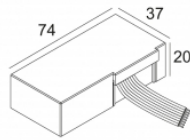

LED POWER CONVERTOR 48V-DC to 500 mA-DC / 22W DIM5
300 48 500 ED5
Nombre de luminaires: 1

[Lien web / Fiche techn.](#)

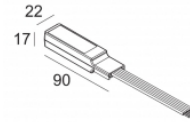

LED POWER CONVERTOR 48V-DC to 500 mA-DC / 22W MDL
300 48 500 MDL
Nombre de luminaires: 1

[Lien web / Fiche techn.](#)

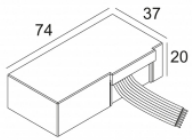

LED POWER CONVERTOR 48V-DC to 500 mA-DC / 22W WDL
300 48 500 WDL
Nombre de luminaires: 1

[Lien web / Fiche techn.](#)

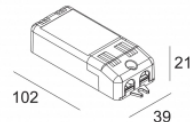

LED POWER SUPPLY 350mA-DC / 10W DIM8
300 90 110
220-240V / 50-60Hz
Nombre de luminaires: 1

[Lien web / Fiche techn.](#)

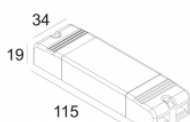

LED POWER SUPPLY 350mA-DC / 15W
300 90 91
110-240V / 50-60Hz
Nombre de luminaires: 2(1)

[Lien web / Fiche techn.](#)

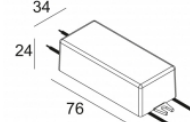

LED POWER SUPPLY 350mA-DC / 16W DIM8
300 90 3112
110-240V / 50-60Hz
Nombre de luminaires: 2(2)

[Lien web / Fiche techn.](#)

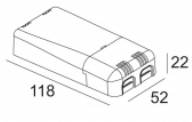

LED POWER SUPPLY 350mA-DC / 18W DIM8
300 90 116
220-240V / 50-60Hz
Nombre de luminaires: 2->2

[Lien web / Fiche techn.](#)

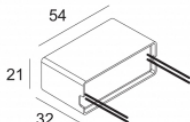

LED POWER SUPPLY 350mA-DC / 8W
300 90 108
110-240V / 0| 50-60Hz
Nombre de luminaires: 1(1)

[Lien web / Fiche techn.](#)

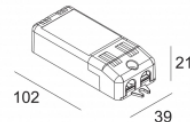

LED POWER SUPPLY 500mA-DC / 11W DIM8
300 90 119
220-240V / 50-60Hz
Nombre de luminaires: 1

[Lien web / Fiche techn.](#)

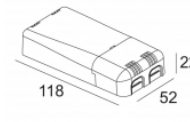

LED POWER SUPPLY 500mA-DC / 20W DIM8
300 90 121
220-240V / 50-60Hz
Nombre de luminaires: 1

[Lien web / Fiche techn.](#)

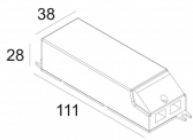

LED POWER SUPPLY 500mA-DC / 21W
300 90 92
110-240V / 0| 50-60Hz
Nombre de luminaires: 2(1)

[Lien web / Fiche techn.](#)

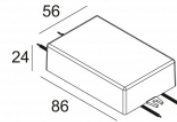

LED POWER SUPPLY 500mA-DC / 22W DIM8
300 90 5120
110-240V / 50-60Hz
Nombre de luminaires: 2->2(2)

[Lien web / Fiche techn.](#)

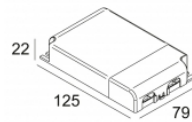

LED POWER SUPPLY MULTI-POWER
300 90 914
110-240V / 50-60Hz
Nombre de luminaires: 3(3) / 3(3) / -

[Lien web / Fiche techn.](#)

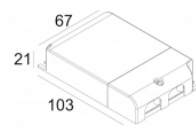

LED POWER SUPPLY MULTI-POWER DIM1
300 90 64
110-240V / 0| 50-60Hz
Nombre de luminaires: 2(1) / 2(1) / -

[Lien web / Fiche techn.](#)

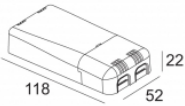

LED POWER SUPPLY MULTI-POWER DIM5
300 90 125
110-240V / 50-60Hz
Nombre de luminaires: 1(1) / 1(1) / -

[Lien web / Fiche techn.](#)

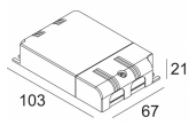

LED POWER SUPPLY MULTI-POWER DIM5
300 90 68
110-240V / 50-60Hz
Nombre de luminaires: 2(1) / 2(1) / -

[Lien web / Fiche techn.](#)

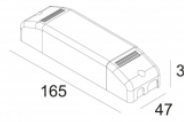

LED POWER SUPPLY MULTI-POWER DIM6
300 90 61
220-240V / 50-60Hz
Nombre de luminaires: 2 / 2 / -

[Lien web / Fiche techn.](#)

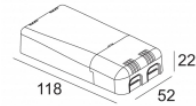

LED POWER SUPPLY MULTI-POWER DIM7
300 90 124
110-240V / 50-60Hz
Nombre de luminaires: 2(2) / 1(1) / -

[Lien web / Fiche techn.](#)

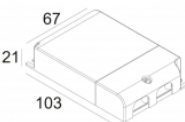

LED POWER SUPPLY MULTI-POWER DIM7
300 90 60
110-240V / 50-60Hz
Nombre de luminaires: 2(2) / 2(1) / -

[Lien web / Fiche techn.](#)

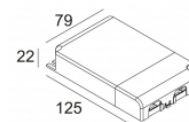

LED POWER SUPPLY MULTI-POWER DIM9
300 90 63
110-240V / 0| 50-60Hz
Nombre de luminaires: 3(3) / 3(3) / -

[Lien web / Fiche techn.](#)

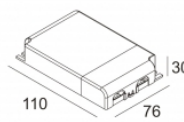

LED POWER SUPPLY MULTI-POWER HV
300 90 135
220-240V / 50-60Hz
Nombre de luminaires: 3->3 / 2->3 / -

[Lien web / Fiche techn.](#)

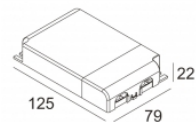

LED POWER SUPPLY MULTI-POWER HV DIM7
300 90 134
110-240V / 50-60Hz
Nombre de luminaires: 5(5) / 4(3) / -

[Lien web / Fiche techn.](#)

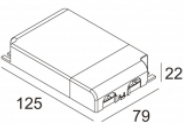

LED POWER SUPPLY MULTI-POWER HV DIM9
300 90 69
110-240V / 50-60Hz
Nombre de luminaires: 5(5) / 4(3) / -

Références alliées
LE KIT DE MONTAGE

[Lien web / Fiche techn.](#)

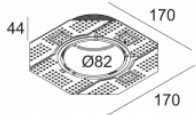

MOUNTING KIT R82 TRIMLESS O.F.A.
202 11 82 OFA

 DELTALIGHT®

DIRO TRIMLESS LED 92733
202 144 811 922

Fiche techn.

Image de projet connexe de la famille de produits:

