

Date \_\_\_\_\_

Name \_\_\_\_\_

Client \_\_\_\_\_

Project Name \_\_\_\_\_

Quote# \_\_\_\_\_

Type/Quantity \_\_\_\_\_

**DEEP RINGO LED IP 92733**  
**202 273 811 922**

[Lien web](#)

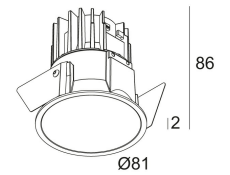
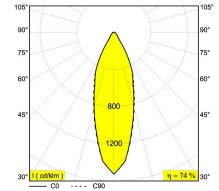

Forme/taille découpée: 76 mm

Profondeur 90 mm

d'encastrement:

Épaisseur de la surface min.5

de montage:

Coloris disponibles: NOIR (202 273 811 922 B)  
 BLANC (202 273 811 922 W)  
 OR MAT (202 273 811 922 MMAT)

NON ADJUSTABLE  
 INCL.1 x LED WHITE 7,1-10,4W / CRI>90 / 2700K / max.1032lm  
 INCL.1 x REFLECTOR FL-33°  
 EXCL.LED POWER SUPPLY 350-500mA-DC

Technics LED: Source lumineuse: 1032 lm // 10 W // 105 lm/W  
 Luminaire: 761 lm // 12 W // 64 lm/W

Classe: III

Poids: 0.3 KG

Niveau de protection: IP44/20

Distance minimale: indisp.

Options: LED POWER SUPPLY 350 / 500mA-DC DIM

Pour obtenir des instructions d'installation détaillées, Consultez le manuel svp

[202 273 811\\_XXX\\_HAND.pdf](#)

DEEP RINGO LED IP 92733

202 273 811 922

### La compatibilité du plafond

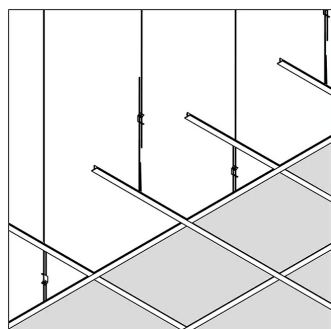

Plafond suspendu

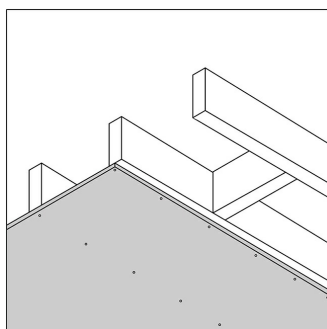

Placoplâtre / BA13

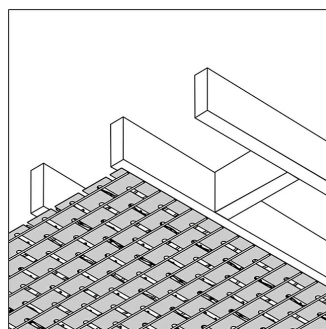

Stucanet

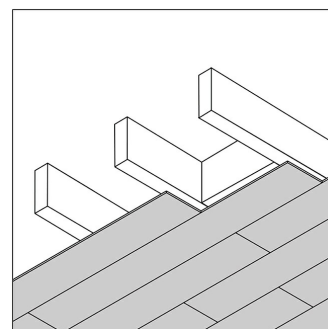

Bois

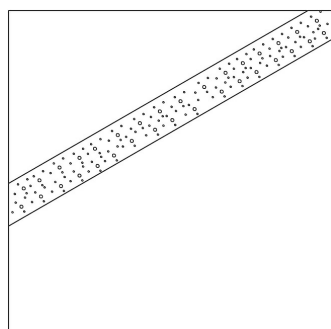

Béton

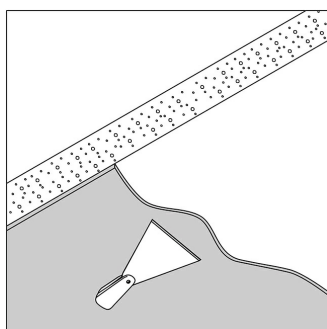

Béton + plâtre

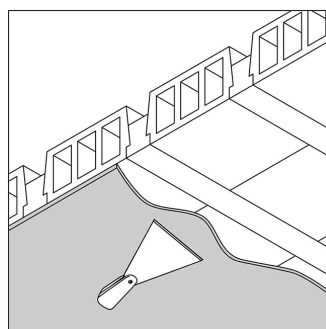

Hourdis béton + plâtre

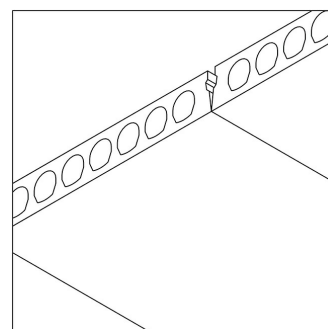

Dalle béton  
préfabriqué

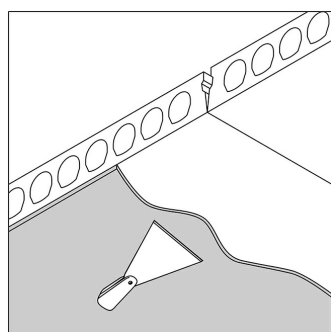

Dalle béton  
préfabriqué + plâtre

Références alliées

LES ALIMENTATIONS LED

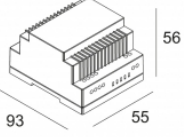
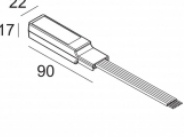
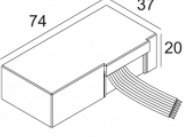
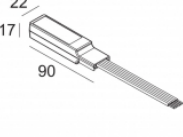
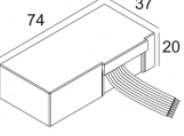
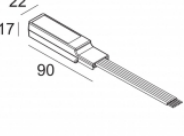
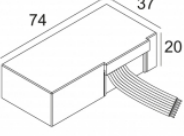
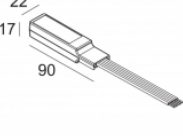
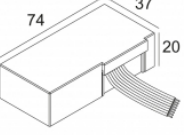
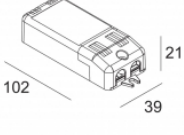
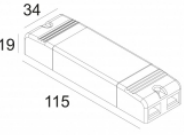
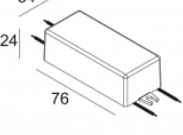
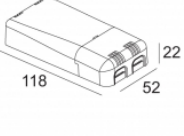
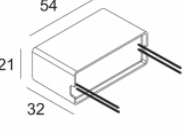
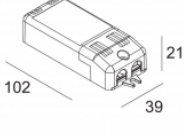
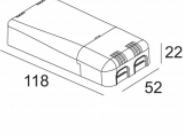
|   |   |  |   |
|---|---|--|---|
| <p><u>Lien web / Fiche techn.</u></p>  <p>LED POWER CONVERTOR 24V-DC TO MULTI CURRENT 48W DIM9<br/>300 90 67<br/>Nombre de luminaires: 2 / - / -</p>         | <p><u>Lien web / Fiche techn.</u></p>  <p>LED POWER CONVERTOR 48V-DC to 350 mA-DC / 15W DIM1<br/>300 48 350 ED1<br/>Nombre de luminaires: 1</p>        | <p><u>Lien web / Fiche techn.</u></p>  <p>LED POWER CONVERTOR 48V-DC to 350 mA-DC / 15W DIM5<br/>300 48 350 ED5<br/>Nombre de luminaires: 1</p>        | <p><u>Lien web / Fiche techn.</u></p>  <p>LED POWER CONVERTOR 48V-DC to 350 mA-DC / 15W MDL<br/>300 48 350 MDL<br/>Nombre de luminaires: 1</p>             |
| <p><u>Lien web / Fiche techn.</u></p>  <p>LED POWER CONVERTOR 48V-DC to 350 mA-DC / 15W WDL<br/>300 48 350 WDL<br/>Nombre de luminaires: 1</p>               | <p><u>Lien web / Fiche techn.</u></p>  <p>LED POWER CONVERTOR 48V-DC to 500 mA-DC / 22W DIM1<br/>300 48 500 ED1<br/>Nombre de luminaires: 1</p>        | <p><u>Lien web / Fiche techn.</u></p>  <p>LED POWER CONVERTOR 48V-DC to 500 mA-DC / 22W DIM5<br/>300 48 500 ED5<br/>Nombre de luminaires: 1</p>        | <p><u>Lien web / Fiche techn.</u></p>  <p>LED POWER CONVERTOR 48V-DC to 500 mA-DC / 22W MDL<br/>300 48 500 MDL<br/>Nombre de luminaires: 1</p>             |
| <p><u>Lien web / Fiche techn.</u></p>  <p>LED POWER CONVERTOR 48V-DC to 500 mA-DC / 22W WDL<br/>300 48 500 WDL<br/>Nombre de luminaires: 1</p>             | <p><u>Lien web / Fiche techn.</u></p>  <p>LED POWER SUPPLY 350mA-DC / 10W DIM8<br/>300 90 110<br/>220-240V / 50-60Hz<br/>Nombre de luminaires: 1</p> | <p><u>Lien web / Fiche techn.</u></p>  <p>LED POWER SUPPLY 350mA-DC / 15W<br/>300 90 91<br/>110-240V / 50-60Hz<br/>Nombre de luminaires: 2(1)</p>    | <p><u>Lien web / Fiche techn.</u></p>  <p>LED POWER SUPPLY 350mA-DC / 16W DIM8<br/>300 90 3112<br/>110-240V / 50-60Hz<br/>Nombre de luminaires: 2(2)</p> |
| <p><u>Lien web / Fiche techn.</u></p>  <p>LED POWER SUPPLY 350mA-DC / 18W DIM8<br/>300 90 116<br/>220-240V / 50-60Hz<br/>Nombre de luminaires: 2-&gt;2</p> | <p><u>Lien web / Fiche techn.</u></p>  <p>LED POWER SUPPLY 350mA-DC / 8W<br/>300 90 108<br/>110-240V / 0  50-60Hz<br/>Nombre de luminaires: 1(1)</p> | <p><u>Lien web / Fiche techn.</u></p>  <p>LED POWER SUPPLY 500mA-DC / 11W DIM8<br/>300 90 119<br/>220-240V / 50-60Hz<br/>Nombre de luminaires: 1</p> | <p><u>Lien web / Fiche techn.</u></p>  <p>LED POWER SUPPLY 500mA-DC / 20W DIM8<br/>300 90 121<br/>220-240V / 50-60Hz<br/>Nombre de luminaires: 1</p>     |

[Lien web / Fiche techn.](#)

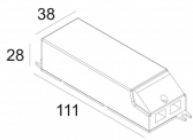

LED POWER SUPPLY 500mA-DC / 21W  
300 90 92  
110-240V / 0|50-60Hz  
Nombre de luminaires: 2(1)

[Lien web / Fiche techn.](#)

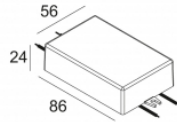

LED POWER SUPPLY 500mA-DC / 22W DIM8  
300 90 5120  
110-240V / 50-60Hz  
Nombre de luminaires: 2->2(2)

[Lien web / Fiche techn.](#)

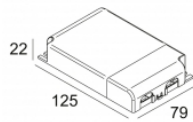

LED POWER SUPPLY MULTI-POWER  
300 90 914  
110-240V / 50-60Hz  
Nombre de luminaires: 3(3) / 3(3) / -

[Lien web / Fiche techn.](#)

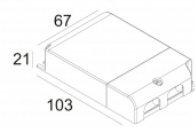

LED POWER SUPPLY MULTI-POWER DIM1  
300 90 64  
110-240V / 0|50-60Hz  
Nombre de luminaires: 2(1) / 2(1) / -

[Lien web / Fiche techn.](#)

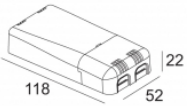

LED POWER SUPPLY MULTI-POWER DIM5  
300 90 125  
110-240V / 50-60Hz  
Nombre de luminaires: 1(1) / 1(1) / -

[Lien web / Fiche techn.](#)

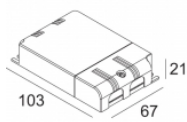

LED POWER SUPPLY MULTI-POWER DIM5  
300 90 68  
110-240V / 50-60Hz  
Nombre de luminaires: 2(1) / 2(1) / -

[Lien web / Fiche techn.](#)

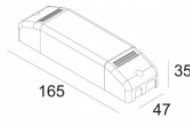

LED POWER SUPPLY MULTI-POWER DIM6  
300 90 61  
220-240V / 50-60Hz  
Nombre de luminaires: 2 / 2 / -

[Lien web / Fiche techn.](#)

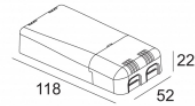

LED POWER SUPPLY MULTI-POWER DIM7  
300 90 124  
110-240V / 50-60Hz  
Nombre de luminaires: 2(2) / 1(1) / -

[Lien web / Fiche techn.](#)

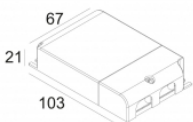

LED POWER SUPPLY MULTI-POWER DIM7  
300 90 60  
110-240V / 50-60Hz  
Nombre de luminaires: 2(2) / 2(1) / -

[Lien web / Fiche techn.](#)

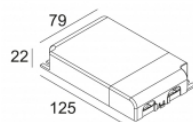

LED POWER SUPPLY MULTI-POWER DIM9  
300 90 63  
110-240V / 0|50-60Hz  
Nombre de luminaires: 3(3) / 3(3) / -

[Lien web / Fiche techn.](#)

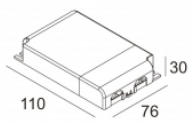

LED POWER SUPPLY MULTI-POWER HV  
300 90 135  
220-240V / 50-60Hz  
Nombre de luminaires: 3->3 / 2->3 / -

[Lien web / Fiche techn.](#)

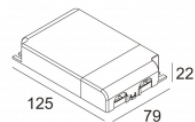

LED POWER SUPPLY MULTI-POWER HV DIM7  
300 90 134  
110-240V / 50-60Hz  
Nombre de luminaires: 5(5) / 4(3) / -

[Lien web / Fiche techn.](#)

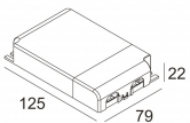

LED POWER SUPPLY MULTI-POWER HV DIM9  
300 90 69  
110-240V / 50-60Hz  
Nombre de luminaires: 5(5) / 4(3) / -

DEEP RINGO LED IP 92733  
**202 273 811 922**

Image de projet connexe de la famille de produits:

