

# User Manual

## Wireless N Exterior Access Point

DAP-3315

---

# Table of Contents

<b>Product Overview</b> .....	<b>4</b>	Intrusion.....	35
Package Contents.....	4	Schedule .....	36
System Requirements .....	5	DHCP Server .....	37
Introduction .....	6	Dynamic Pool Settings.....	37
Features.....	8	Static Pool Settings .....	38
Hardware Overview.....	9	Current IP Mapping List.....	39
Connections .....	9	Filter.....	40
LEDs .....	10	MAC Address ACL .....	40
<b>Installation</b> .....	<b>11</b>	WLAN Partition .....	41
Wireless Installation Considerations.....	13	View Log.....	42
<b>Configuration</b> .....	<b>14</b>	Log Settings.....	43
Web-based Configuration Utility.....	14	DMZ (WISP mode only) .....	44
Operating Modes.....	15	Virtual Server (WISP mode only) .....	45
Basic Settings .....	16	Port Forwarding (WISP mode only).....	46
Wireless Settings.....	17	Parental Control (WISP mode only).....	47
WDS .....	22	IP Routing (WISP mode only) .....	48
Wireless LAN Settings(Repeater mode).....	23	Maintenance .....	49
LAN Settings.....	24	Administration Settings .....	49
Advanced Settings .....	25	Firmware and SSL Certification Upload.....	50
Performance .....	25	Configuration File .....	51
Wireless Resource .....	28	Time and Date.....	52
Multi-SSID.....	30	Status .....	53
VLAN.....	31	Device Information .....	53
Port List.....	32	Client Information .....	54
Add/Edit VLAN .....	33	Ethernet Information.....	55
PVID Settings.....	34	WLAN Information .....	56
		Configuration.....	57

Save and Activate .....	57
Discard Changes .....	58
System .....	59
Help .....	60
<b>Troubleshooting .....</b>	<b>61</b>
<b>Technical Specifications .....</b>	<b>64</b>
<b>Antenna Pattern .....</b>	<b>66</b>

# Package Contents

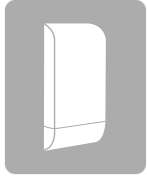

DAP-3315 Wireless N Exterior Access Point

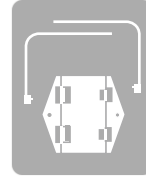

Wall Mount



Power Over Ethernet Injector



Quick Installation Guide

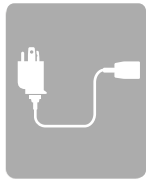

Power cord

**Note:** Using a PoE Injector with a different voltage rating or PoE injector than the one included with the DAP-3315 will cause damage and void the warranty for this product.

# System Requirements

<b>Network Requirements</b>	<ul style="list-style-type: none"><li>• An Ethernet-based Network</li><li>• IEEE 802.11n/g wireless clients (AP Mode)</li><li>• IEEE 802.11n/g wireless network (AP Mode)</li></ul>
<b>Web-based Configuration Utility Requirements</b>	<p><b>Computer with the following:</b></p> <ul style="list-style-type: none"><li>• Windows®, Macintosh, or Linux-based operating system</li><li>• An installed Ethernet adapter</li></ul> <p><b>Browser Requirements:</b></p> <ul style="list-style-type: none"><li>• Internet Explorer® 11 and higher</li><li>• Mozilla Firefox 28 and higher</li><li>• Google™ Chrome 33 and higher</li><li>• Apple Safari 7 and higher</li></ul> <p><b>Windows® Users:</b> Make sure you have the latest version of Java installed. Visit <a href="http://www.java.com">www.java.com</a> to download the latest version.</p>

# Introduction

D-Link, an industry leader in networking, introduces the new D-Link DAP-3315 Wireless N Exterior Access Point. With the ability to transfer files with a maximum wireless signal rate of up to 300 Mbps<sup>1</sup>, the DAP-3315 gives you ability to add high-speed wireless network access to places outside of your internal networking environment. Additional operation modes such as WDS and WISP also make the DAP-3315 perfect for those needing to span longer distances wirelessly.

The DAP-3315 is Wi-Fi IEEE 802.11n compliant, meaning that it can connect and interoperate with other 802.11n compatible wireless client devices. The DAP-3315 is also backwards compatible with 802.11b/g devices. With its Setup Wizard, the DAP-3315 ensures that you will be up and running a wireless network in just a matter of minutes.

The DAP-3315 features Wi-Fi Protected Access (WPA-PSK/WPA2-PSK) to provide an enhanced level of security for wireless data communications. The DAP-3315 also includes additional security features to keep your wireless connection safe from unauthorized access.

<sup>1</sup> Actual data throughput will vary. Network conditions and environmental factors, including volume of network traffic, building materials and construction, and network overhead, lower actual data throughput rate.

### **Ultimate Performance**

The D-Link Wireless N Exterior Access Point (DAP-3315) is an 802.11n compliant device that delivers real world performance of up to 300 Mbps<sup>2</sup>, much faster than an 802.11g wireless connection (also faster than a 100 Mbps wired Ethernet connection). Create a secure wireless network to share photos, files, music, video, printers, and network storage outside of your normal internal networking environment. Built to withstand harsh environments, the DAP-3315 also excels in connecting separate networks that cannot be joined physically using traditional medium. The built-in 10dBi sector antenna is designed to deliver high powered performance, ensuring that wireless coverage will cover even hard to reach locations.

### **Multiple Operation Modes**

The DAP-3315 features seven different operation modes, allowing it to adapt to any situation. As a standard wireless access point (AP) the DAP-3315 can connect to a wide range of devices that are 802.11 n/g/b compliant. In wireless distribution system (WDS) mode it can expand current wireless coverage without the need for a wired backbone link. As a wireless client it can connect to an existing AP, and expand the network physically with the two built-in 10/100 Ethernet ports. Repeater mode will extend current wireless coverage eliminating dead spots and weak signals.

Also built into the DAP-3315 is WISP mode, which expands functionality for long range communications by including the ability to function as a client or repeater. In WISP Repeater mode, the AP wirelessly connects to a WISP (Wireless Internet Service Provider) AP and repeats the signal received from the WISP. In this mode, the AP also acts as a router for both wireless and wired clients on your LAN. In WISP Client Router mode, the AP wirelessly connects to a WISP (Wireless Internet Service Provider) AP and acts as a router for wired clients on the LAN, to allow the client to still access the Internet even though it is using wireless technology.

### **Total Security**

The DAP-3315 supports 64/128-bit WEP data encryption and WPA/WPA2 security functions. In addition, it provides MAC Address Filtering to control user access, and the Disable SSID Broadcast function to limit unauthorized access to the internal network. Network administrators have multiple options for managing the DAP-3315, including Web (HTTP) or Secured Web (HTTPS).

<sup>2</sup> Maximum wireless signal rate derived from IEEE Standard 802.11g and 802.11n specifications. Actual data throughput will vary. Network conditions and environmental factors, including volume of network traffic, building materials and construction, and network overhead, lower actual data throughput rate. Environmental conditions will adversely affect wireless signal range.

# Features

- **Faster Wireless Networking** - The DAP-3315 provides an up to 300 Mbps\* wireless connection with other 802.11n wireless clients. This capability allows users to participate in real-time activities online, such as video streaming, online gaming, and real-time audio.
- **Compatible with IEEE802.11g Devices** - The DAP-3315 is still fully compatible with the 802.11g standards, so it can connect with existing 802.11g adapters.
- **Built-in High Gain Sector Antenna** - The DAP-3315 comes equipped with a high powered 12 dBi antenna that helps to provide better wireless coverage and increases signal strength.
- **Convenient Installation** - The DAP-3315 features a wall/pole mount in the rear for easy setup on poles or walls.
- **Rugged Construction** - The DAP-3315 is built to withstand harsh environments, and is compliant with the Waterproof IPx5 Standard.<sup>3</sup>

<sup>3</sup> IPx5 standard means the device is protected from low pressure jets of water from all directions - limited ingress permitted. It is recommended to place this device under a roof, shelter or in weather-proof box when in severe weather environment.



# Hardware Overview

## Connections

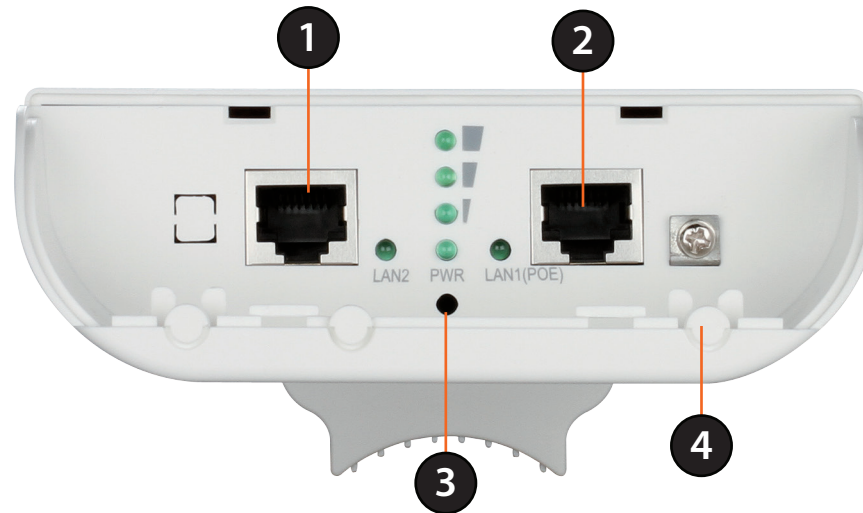

<b>1</b>	<b>LAN Port</b>	Connects to 10/100 Ethernet devices such as computers, switches, and hubs.
<b>2</b>	<b>LAN (PoE) Port</b>	Power is supplied through the LAN cable connected in this port via the Power over Ethernet Injector. Please see "Installation" on page 11 for more details on how to correctly power the DAP-3315 and connect to other networking devices.
<b>3</b>	<b>Reset Button</b>	Hold the reset button for at least 5 seconds to reset the device back to the factory default settings. All the LEDs will turn on for 2 second and then begin the reboot process.
<b>4</b>	<b>Grounding Wire Connector</b>	Connects to a grounding wire.

**Note:** The DAP-3315 uses a proprietary PoE injector which is needed to function correctly. Only use the included PoE injector as other power sources such as 3rd party PoE injectors or PoE switches or hubs may damage the DAP-3315 or cause it to operate unreliably, and will also void the warranty.

# Hardware Overview

## LEDs

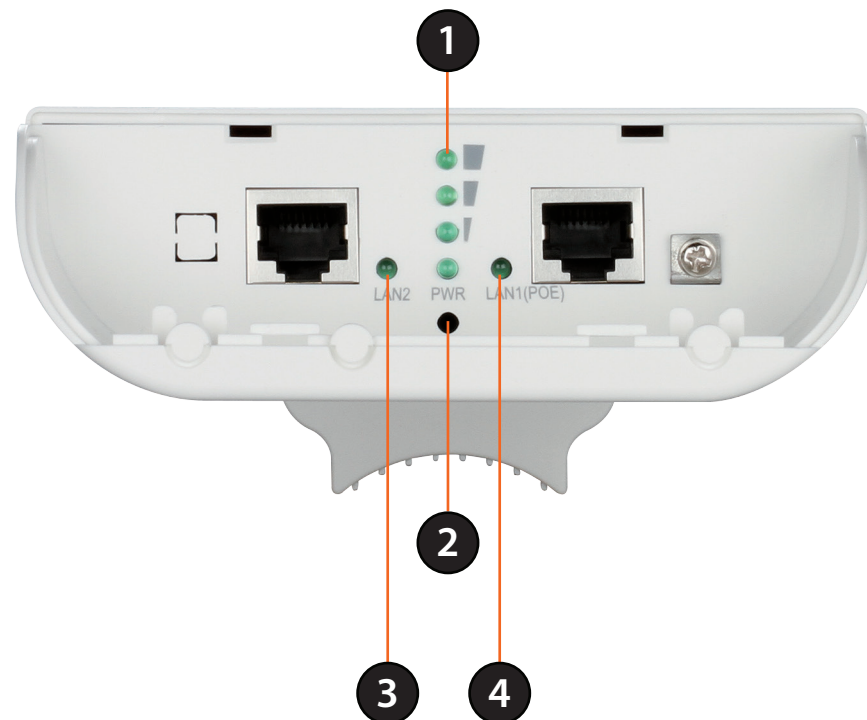

1	<b>Wireless Signal Strength LED</b>	Shows different signal strength levels. (Only supported in Wireless Client, Repeater, WDS, and WISP mode)
2	<b>Power LED</b>	A solid green light indicates the device is powered and ready.
3	<b>LAN LED</b>	A solid green light indicates the LAN port connection is OK. A blinking green light indicates that the unit is transmitting data over that port.
4	<b>LAN LED (PoE)</b>	A solid green light indicates the LAN port (PoE) connection is OK. A blinking green light indicates that the unit is transmitting data over that port.

# Installation

First, you will need to configure the DAP-3315 with a computer connected directly to the unit. The following pages explain how to set up the DAP-3315 in order to be properly configured and then tested to work as desired.

The DAP-3315 acts as a central connection point for any device (client) that has a 802.11n or backward-compatible 802.11g wireless network interface and is within range of the AP. Clients must use the same SSID (wireless network name) and channel as the AP in order to connect. If wireless security is enabled on the AP, the client will need to enter a password to connect to the AP. In Access Point mode, multiple clients can connect to the AP at the same time.

STEP 1: Connect an Ethernet Cable to the LAN (PoE) Port on the AP.

The port connection cover can be removed using a small amount of force so that it pops off. It can be reattached by snapping it back into place.

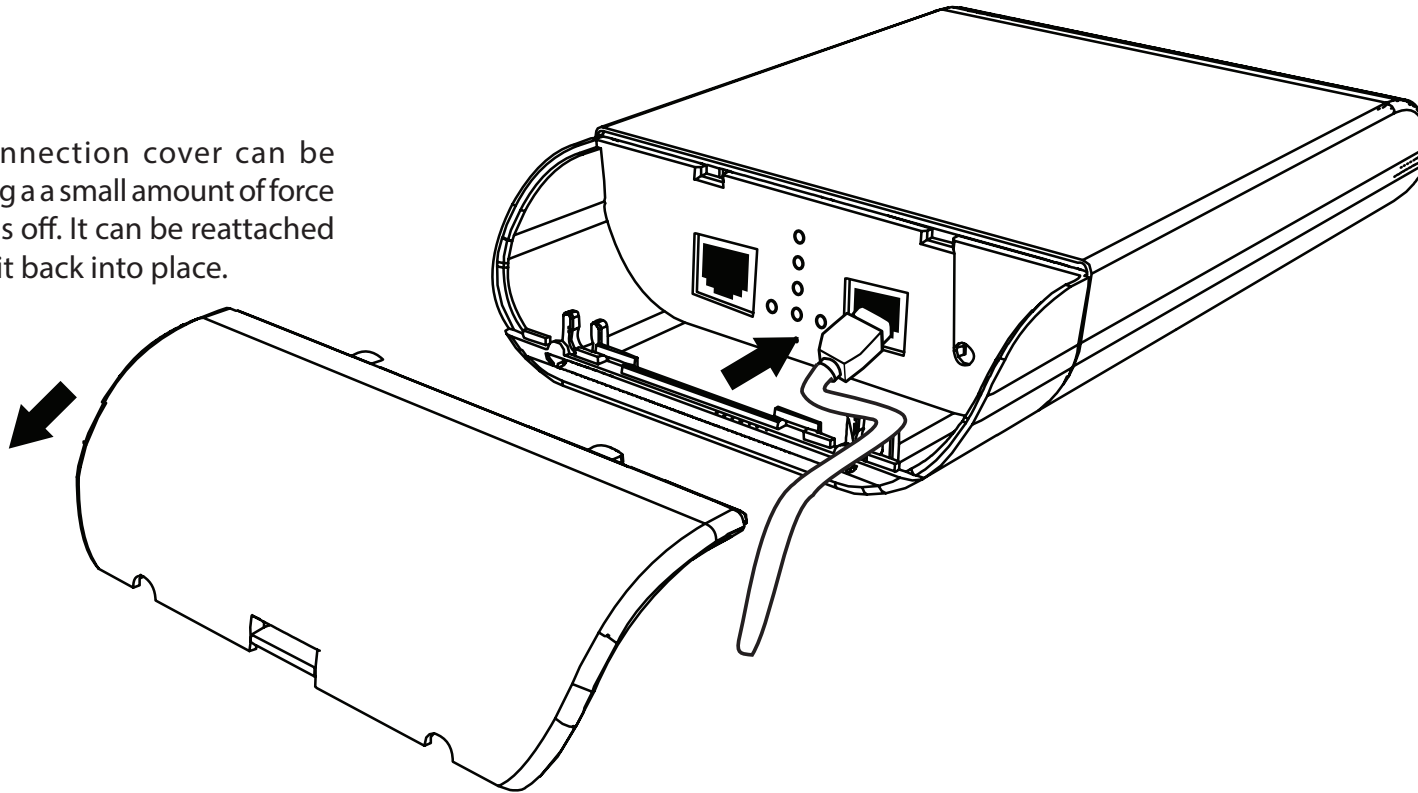

STEP 2: Connect the AP to Your Network

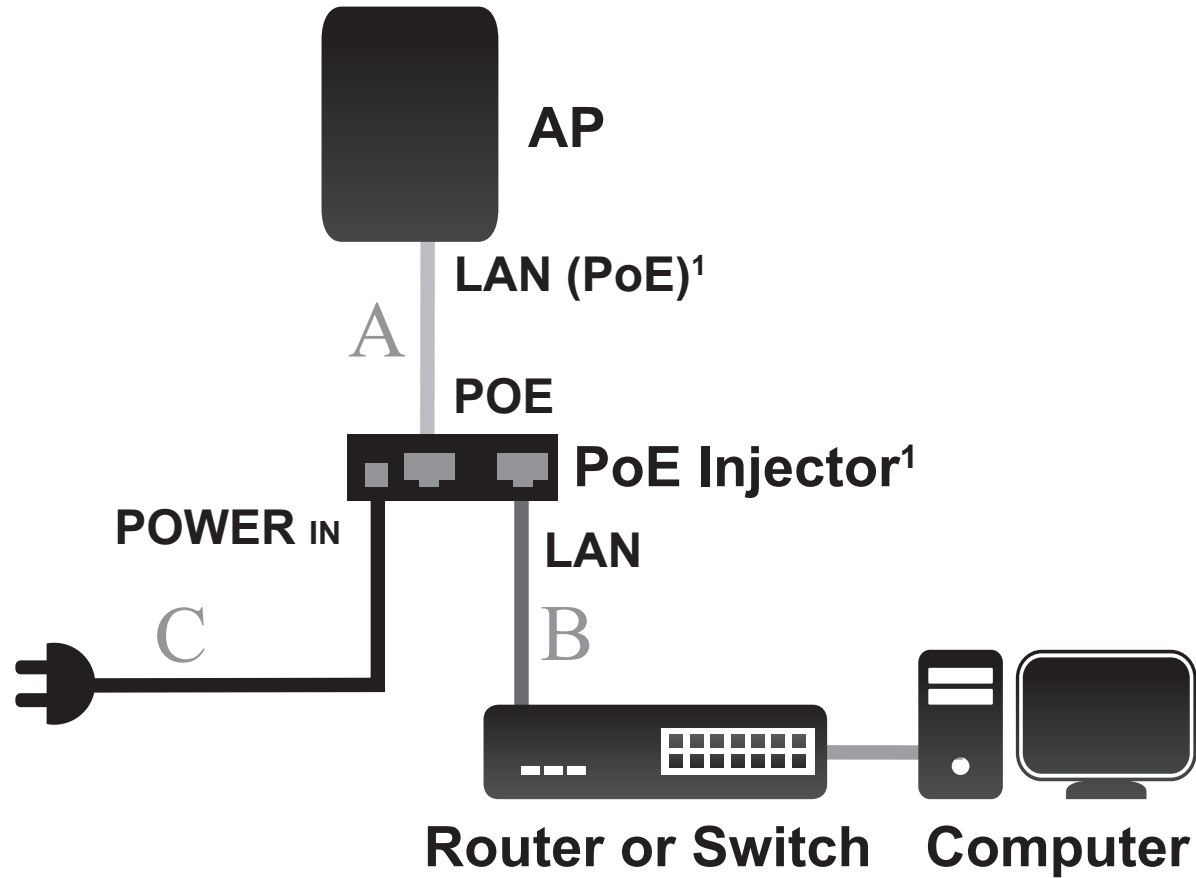

- A. Connect the Ethernet cable that is connected to the AP from STEP 1 to the POE port on the PoE Injector.
- B. Connect an Ethernet cable from a router, switch, or PC to the LAN port on the PoE Injector.
- C. Attach the power cord to connect PoE injector, and plug it into an electrical outlet.

<sup>1</sup>This product uses a proprietary PoE design and can only be used with the included PoE injector.

# Wireless Installation Considerations

The D-Link Wireless N Exterior Access Point lets you access your network using a wireless connection from virtually anywhere within the operating range of your wireless network. Keep in mind, however, that the number, thickness and location of walls, ceilings, or other objects that the wireless signals must pass through, may limit the range. Typical ranges vary depending on the types of materials and background RF (radio frequency) noise in your home or business. The key to maximizing wireless range is to follow these basic guidelines:

1. Keep the number of walls and ceilings between the D-Link access point and other network devices to a minimum. Each wall or ceiling can reduce your adapter's range from 3-90 feet (1-30 meters). Position your devices so that the number of walls or ceilings is minimized.
2. Be aware of the direct line between network devices. A wall that is 1.5 feet thick (.5 meters), at a 45-degree angle appears to be almost 3 feet (1 meter) thick. At a 2-degree angle it looks over 42 feet (14 meters) thick! Position devices so that the signal will travel straight through a wall or ceiling (instead of at an angle) for better reception.
3. Building materials make a difference. A solid metal door or aluminum studs may have a negative effect on range. Try to position access points, wireless access points, and computers so that the signal passes through drywall or open doorways. Materials and objects such as glass, steel, metal, walls with insulation, water (fish tanks), mirrors, file cabinets, brick, and concrete will degrade your wireless signal.
4. Keep your product away (at least 3-6 feet or 1-2 meters) from electrical devices or appliances that generate RF noise.
5. If you are using 2.4GHz cordless phones or X-10 (wireless products such as ceiling fans, lights, and home security systems), your wireless connection may degrade dramatically or drop completely. Make sure your 2.4 Hz phone base is as far away from your wireless devices as possible. The base transmits a signal even if the phone is not in use.

# Configuration

This section will show you how to configure your new D-Link Wireless N Exterior Access Point using the web-based configuration utility.

## Web-based Configuration Utility

If you wish to change the default settings or optimise the performance of the DAP-3315, you may use the web-based configuration utility.

To access the configuration utility, open a web browser such as Internet Explorer and enter **http://192.168.0.50**

Select **admin** and then enter your password. Leave the password blank by default.

If you get a Page Cannot be Displayed error, please refer to **“Troubleshooting”** on page 61 for assistance.

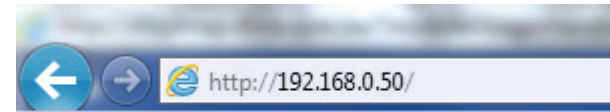

# Operating Modes

The DAP-3315 features seven different operating modes, allowing it to adapt to any situation. Select the operating mode by clicking on the radio button, that corresponds to the desired mode then click on **Change Mode**. After confirming that the operating mode will be changed, the AP will reboot and will be ready for use after 40 seconds.

**Access Point:** In access point (AP) mode, 802.11n/g/b compliant devices can connect to the wireless network.

**WDS with AP:** Wireless distribution system (WDS) with AP mode expands current wireless coverage and also allows devices to connect to the network.

**WDS:** Wireless distribution system (WDS) mode expands current wireless coverage from other Wireless AP devices that are in WDS mode.

**Wireless Client:** As a wireless client the DAP-3315 can connect to an existing AP and expand the network physically with the two built-in 10/100 Ethernet ports.

**Repeater:** Repeater mode will extend current wireless coverage, alleviating dead spots and weak signals.

**WISP Client Router:** WISP Client Router mode allows for the sharing of a WISP connection using the two built-in 10/100 Ethernet ports.

**WISP Repeater:** WISP Repeater mode will extend an existing WISP's network coverage area.

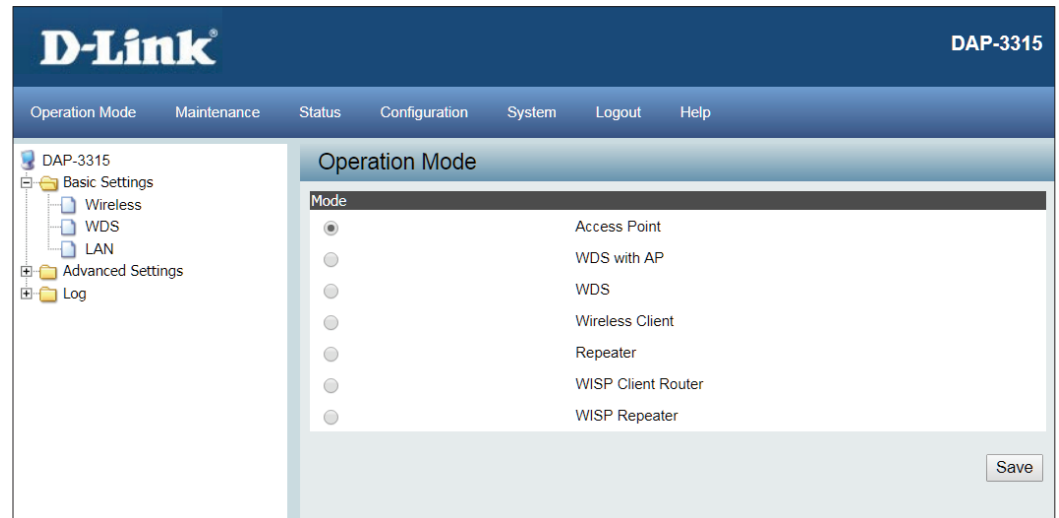

# Basic Settings

The image to the right shows a configuration menu tree for when the AP is in Access Point mode. If you need help determining which operating mode the AP is currently in, please see "Operating Modes" on page 15.

**Note:** The DAP-3315 has different configuration options depending on the current operating mode. Please be aware that some screens and menus will not be present unless the AP is operating in an applicable operating mode.

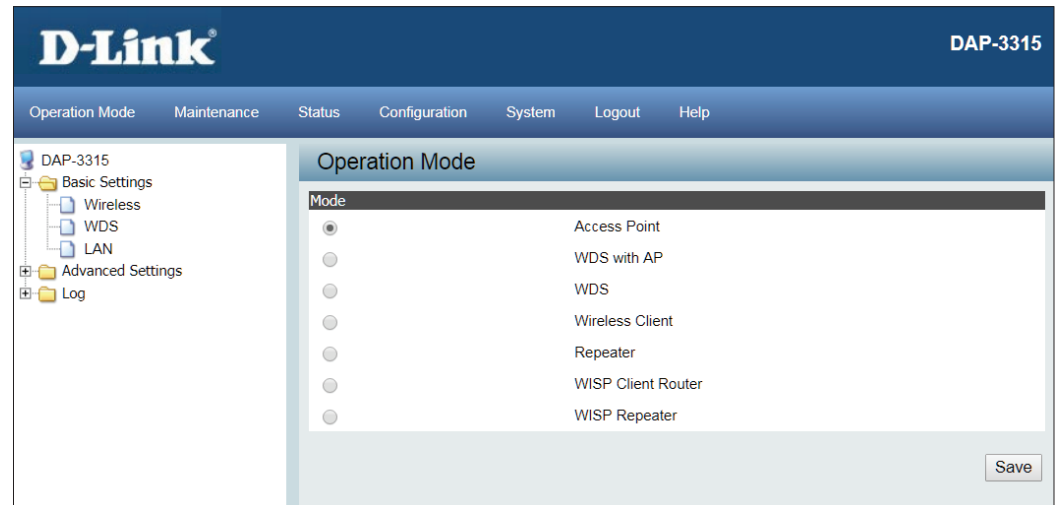



# Wireless Settings

This page will allow you to configure the wireless connection for the DAP-3315. Please be aware that some menu options will change depending on which type of security setting is used.

**Network Name (SSID):** Enter a name for your wireless network (SSID). For security purposes, it is highly recommended to change from the default network name.

**SSID Visibility:** Select **Disabled** if you do not want the SSID of your wireless network to be broadcasted by the DAP-3315. Your wireless clients will have to know the SSID of your DAP-3315 in order to connect to it.

**Auto Channel Selection:** The Auto Channel Scan setting can be selected to allow the DAP-3315 to choose the channel with the least amount of interference.

**Channel:** Indicates the channel setting for the DAP-3315. The Channel can be changed to fit the channel setting for an existing wireless network or to customize the wireless network. If you enable Auto Channel Scan, this option will be grayed out.

**Channel Width:** Auto 20/40 - Select if you are using both 802.11n and non-802.11n wireless devices. 20MHz - Select if you are not using any 802.11n wireless clients.

**Extension** Used only when **Channel width** is set to 40 MHz.

**Channel:** Select the desired channel bonding for control.

The screenshot displays the D-Link DAP-3315 configuration interface. The top navigation bar includes 'Operation Mode', 'Maintenance', 'Status', 'Configuration', 'System', 'Logout', and 'Help'. The left sidebar shows a tree view with 'DAP-3315' expanded to 'Basic Settings', where 'Wireless' is selected. The main panel, titled 'Wireless Settings', contains the following fields:

- Network Name (SSID):
- SSID Visibility:
- Auto Channel Selection:
- Channel:
- Channel Width:
- Authentication:
- Key Settings**
  - Encryption:  Disable  Enable
  - Key Type:  Key Size:
  - Key Index (1-4):
  - Network Key:

A 'Save' button is located at the bottom right of the settings panel.

## Open System/Shared Key Authentication

If you selected Open System as your Authentication, you will see these settings:

**Encryption:** Use the radio button to disable or enable encryption. (Encryption option only available with Open System setting)

**Key Type:** Select either **HEX** or **ASCII** as the key type.

**Key Size:** Select **64 Bits** or **128 Bits** for your key size.

**Key Index:** Select which key you want to be the active key.

**Network Key:** Input up to four keys for encryption. You will select one of these keys in the Key Index drop-down menu.

**Confirm Key:** Confirm the network key.

Click **Save** to commit your changes.

**Note:** Hexadecimal (HEX) digits consist of the numbers 0-9 and the letters A-F.

ASCII (American Standard Code for Information Interchange) is a code that represents English letters using numbers ranging from 0-127.

The screenshot shows the D-Link DAP-3315 configuration interface. The 'Wireless Settings' section is active, displaying various configuration options. The 'Authentication' is set to 'Shared Key'. Under 'Key Settings', 'Encryption' is set to 'Enable', 'Key Type' is 'ASCII', and 'Key Size' is '64 Bits'. The 'Key Index' is set to '1'. The 'Network Key' field is empty. A 'Save' button is visible at the bottom right of the configuration area.

## WPA/WPA2-Personal Authentication

If you selected WPA/WPA2-Personal Authentication as your Authentication, you will see these settings:

**WPA Mode:** When **WPA-Personal** is selected for Authentication type, you must also select a WPA mode from the drop-down menu: **AUTO (WPA or WPA2)**, **WPA2 Only**, or **WPA Only**. WPA and WPA2 use different algorithms. **AUTO (WPA or WPA2)** allows you to use both WPA and WPA2.

**Cipher Type:** When you select **WPA-Personal**, you must also select **AUTO**, **AES**, or **TKIP** from the drop-down menu.

**Group Key Update:** Select the interval during which the group key will be valid. The default value of **1800** is recommended. Select **Manual** to enter your key (Passphrase).

**Passphrase / Confirm Passphrase:** When you select **WPA-Personal**, please enter a Passphrase in the corresponding fields.

## WPA/WPA2-Enterprise Authentication

**WPA Mode:** When WPA-Enterprise is selected, you must also select a WPA mode from the drop-down menu: AUTO (WPA or WPA2), WPA2 Only, or WPA Only. WPA and WPA2 use different algorithms. AUTO (WPA or WPA2) allows you to use both WPA and WPA2.

**Cipher Type:** When WPA-Enterprise is selected, you must also select a cipher type from the drop-down menu: Auto, AES, or TKIP.

**Group Key Update Interval:** Select the interval during which the group key will be valid. The recommended value is 1800. A lower interval may reduce data transfer rates.

**RADIUS Server:** Enter the IP address of your RADIUS server.

**RADIUS Port:** Enter the RADIUS port.

**RADIUS Secret:** Enter the RADIUS secret.

**D-Link** DAP-3315

Operation Mode Maintenance Status Configuration System Logout Help

DAP-3315

- Basic Settings
  - Wireless
  - LAN
- Advanced Settings
- Log

### Wireless Settings

Network Name (SSID)

SSID Visibility

Auto Channel Selection

Channel

Channel Width

Authentication

#### RADIUS Server Settings

WPA Mode

Cipher Type  Group Key Update Interval  (Sec)

RADIUS Server (2.4GHz)

Key Update Interval  second(s)

#### RADIUS Server Mode

RADIUS Server  External  Internal

#### Primary RADIUS Server Setting

RADIUS Server  Radius Port

RADIUS Secret

(0-9,a-z,A-Z,~!@#\$%^&\*()\_+ '-=|:;'.</p>
</div>
<div data-bbox="41 942 243 965" data-label="Page-Footer>D-Link DAP-3315 User Manual</div>
<div data-bbox="937 942 963 965" data-label="Page-Footer>20</div>

## 802.1x Authentication

**RADIUS Server:** Enter the IP address of your RADIUS server.

**RADIUS Port:** Enter the RADIUS port.

**RADIUS Secret:** Enter the RADIUS secret.

The screenshot displays the D-Link DAP-3315 configuration web interface. The top navigation bar includes 'Operation Mode', 'Maintenance', 'Status', 'Configuration', 'System', 'Logout', and 'Help'. The left sidebar shows a tree view with 'Basic Settings', 'Wireless', 'LAN', 'Advanced Settings', and 'Log'. The main content area is titled 'Wireless Settings' and contains the following configuration options:

- Network Name (SSID):
- SSID Visibility:
- Auto Channel Selection:
- Channel:
- Channel Width:
- Authentication:

**RADIUS Server Settings**

RADIUS Server (2.4GHz)

Key Update Interval:  second(s)

**RADIUS Server Mode**

RADIUS Server:  External  Internal

**Primary RADIUS Server Setting**

RADIUS Server:  Radius Port:

RADIUS Secret:

(0-9,a-z,A-Z,~|@#%&^&(\*)\_+ '-=|[]:;".,/<>?)

**Backup RADIUS Server Setting (Optional)**

RADIUS Server:  Radius Port:

RADIUS Secret:

(0-9,a-z,A-Z,~|@#%&^&(\*)\_+ '-=|[]:;".,/<>?)

# WDS

**Wireless Band:** 2.4GHz(DAP-3315 is 2.4GHz Access Point

**WDS (Wireless Distribution System):** This feature will be enabled automatically when select WDS or WDS with AP mode in operation page. For other operation mode it is disabled.

**Network Name (SSID):** Input the name for WDS connection. Access Points use the same name can establish WDS connection together.

**AP MAC Address:** Input the MAC address of uplink AP to establish WDS link.

**Site Survey:** Click on the Scan button to search for available APs, then click on the available AP that you want to connect with. For example, if you want establish WDS link with uplink AP by using SSID name "abcd", you can type "abcd" on SSID name and click scan to find if there has AP with SSID name as "abcd".

**Authentication:** Suggest to select WPA-Personal and WPA2 Only on WPA mode if you want data encryption in WDS connection.

Please click Save button to save the configuration.

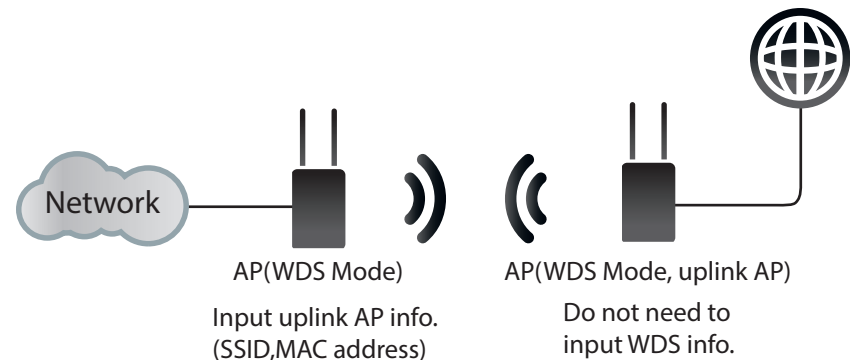
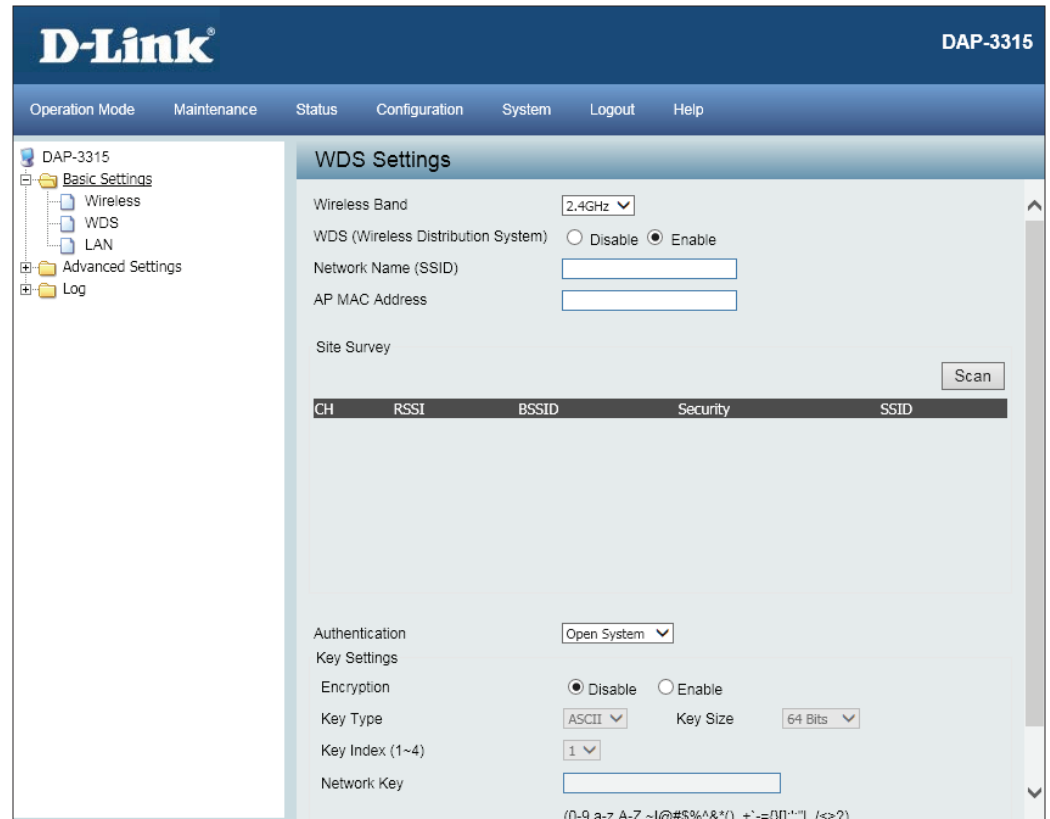

## Wireless LAN Settings(Repeater mode)

This page will allow you to change the wireless LAN settings of the AP. This function is used when there are multiple access points that are connected to increase wireless coverage over an area.

**Repeater Network Name:** Set this to the SSID of the wireless network that the DAP-3315 will be connecting to.

**Local Wi-Fi Network Name:** This option can either be set to rebroadcast the wireless network that the DAP-3315 is connected to, or it can broadcast a different SSID.

**Authentication:** The wireless LAN security can be **Open System, WPA-Personal, WPA-Enterprise, or 802.1x**.

For a detailed description of the Open System parameters, please go to page 18.

For a detailed description of the WPA-Personal parameters, please go to page 19.

For a detailed description of the WPA-Enterprise parameters, please go to page 20.

For a detailed description of the 802.1x parameters, please go to page 21.

The screenshot displays the D-Link DAP-3315 configuration interface. The top navigation bar includes 'Operation Mode', 'Maintenance', 'Status', 'Configuration', 'System', 'Logout', and 'Help'. The main content area is titled 'Wireless LAN Settings' and contains the following fields:

- Repeater Network Name:** A text input field.
- Local Wi-Fi Network Name:** Two radio button options: 'Same as Repeater Network Name' (selected) and 'Create a new Wi-Fi Network Name'.
- Authentication Method:** A dropdown menu set to 'Open System'.
- Key Settings:**
  - Encryption:** Radio buttons for 'Disable' (selected) and 'Enable'.
  - Key Type:** A dropdown menu set to 'ASCII (5)'.
  - Key Size:** A dropdown menu set to '64 Bits'.
  - Default Key:** A dropdown menu set to 'Key 1'.
  - Encryption Key:** A text input field with a validation pattern: (0-9,a-z,A-Z,~!@#\$%^&\*()\_+ '-=|[]:;"/<>?)

A 'Save' button is located at the bottom right of the configuration area.

# LAN Settings

This section will allow you to change the local network settings of the DAP-3315. After making your changes, click the **Save** button.

**Get IP From:** Select an option to choose how the AP will obtain an IP address to use on the local network. If this is set to **Static**, you will need to manually enter the necessary information.

**IP Address:** Enter the IP address of the router. The default IP address is 192.168.0.50. If you change the IP address, once you click Save, you will need to enter the new IP address in your browser to get back into the configuration utility.

**IP Subnet Mask:** Enter the Subnet Mask. The default subnet mask is 255.255.255.0.

**Default Gateway:** Enter the gateway IP Address for your local network.

**DNS:** Configure the IP address of the preferred DNS server.

The screenshot shows the D-Link DAP-3315 configuration utility. The top navigation bar includes 'Operation Mode', 'Maintenance', 'Status', 'Configuration', 'System', 'Logout', and 'Help'. The 'Configuration' menu is expanded, showing 'Basic Settings', 'Wireless', 'LAN', 'Advanced Settings', and 'Log'. The 'LAN Settings' page is active, displaying the following fields:

Get IP From	<input type="text" value="Static IP (Manual)"/>
IP Address	<input type="text" value="192.168.0.50"/>
Subnet Mask	<input type="text" value="255.255.255.0"/>
Default Gateway	<input type="text" value="192.168.0.1"/>
DNS	<input type="text"/>

A 'Save' button is located at the bottom right of the configuration area.



# Advanced Settings

## Performance

This options on this page will allow you to fine tune the wireless connectivity of the access point.

**Wireless:** Use the drop-down menu to turn the wireless function **On** or **Off**.

**Wireless Mode:** The different combination of clients that can be supported include **Mixed 802.11n, 802.11g and 802.11b, Mixed 802.11g and 802.11b** and **802.11n Only**.

**Note:** When backwards compatibility is enabled for legacy (802.11g/b) clients, degradation of 802.11n wireless performance is expected.

**Data Rate:** Set the base transfer rate of wireless adapters on the wireless LAN. The AP will adjust the base transfer rate depending on the base rate of the connected device. This option is enabled in **Mixed 802.11g and 802.11b** mode. The choices available are **Best (Up to 54), 54, 48, 36, 24, 18, 12, 9, 6, 11, 5.5, 2** or **1**.

**Beacon Interval:** Beacons are packets sent by an access point to synchronize a wireless network. Specify a value in milliseconds. The default (**100**) is recommended. Setting a higher beacon interval can help to save the power of wireless clients, while setting a lower one can help a wireless client connect to an access point faster.

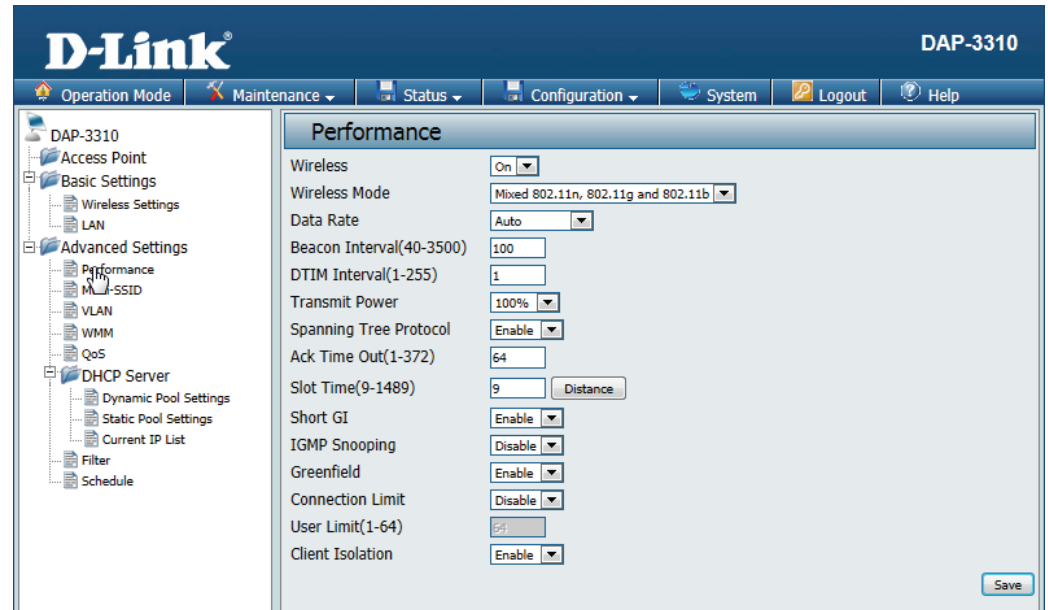

**DTIM Interval** Set a Delivery Traffic Indication Message setting between 1 and 255. The default value is 1. DTIM is a countdown informing clients of the next window for listening to broadcast and multicast messages.

**Transmit Power:** This setting determines the power level of the wireless transmission. Transmitting power can be adjusted to eliminate overlapping of wireless area coverage between two access points where interference is a major concern. For example, if wireless coverage is intended for half of the area, then select 50% as the option. Use the drop-down menu to select 100%, 50%, 25%, or 12.5%.

**WMM:** Select whether to **Enable** or **Disable** the WMM functionality of the access point.

**Ack Time Out:** To effectively optimize throughput over long distance links, enter a value for Acknowledgement Time Out from 1 to 372 microseconds in the 2.4 GHz in the field provided.

**Short GI:** Select **Enable** or **Disable**. Enabling a short guard interval can increase throughput. However, be aware that it can also increase the error rate in some installations due to increased sensitivity to radio-frequency installations.

The screenshot displays the D-Link DAP-3315 web interface. The top navigation bar includes 'Operation Mode', 'Maintenance', 'Status', 'Configuration', 'System', 'Logout', and 'Help'. The left sidebar shows a tree view of settings categories: Basic Settings (Wireless, LAN), Advanced Settings (Performance, Wireless Resource, Multi-SSID, Internal RADIUS Server, RADIUS Accounts, VLAN, Intrusion), DHCP Server (Filters, WLAN Partition, Schedule), and Log. The main content area is titled 'Performance Settings' and contains the following configuration options:

- Wireless: On
- Wireless Mode: Mixed 802.11b, 802.11g, 802.11n
- Data Rate: Best (Up to 300) Mbps
- Beacon Interval (40-500): 100
- DTIM Period (1-15): 1
- Transmit Power: 100%
- WMM (Wi-Fi Multimedia): Enable
- Ack Time Out: 64 (μs)
- Short GI: Enable
- IGMP Snooping: Disable
- Multicast Rate: Disable Mbps
- HT 20/40 Coexistence: Enable
- Greenfield: Enabled
- Transfer DHCP Offer to Unicast: Disable

A 'Save' button is located at the bottom right of the settings area.

**IGMP Snooping:** Select **Enable** or **Disable**. Internet Group Management Protocol allows the AP to recognize IGMP queries and reports sent between routers and an IGMP host (wireless STA). When IGMP snooping is enabled, the AP will forward multicast packets to an IGMP host based on IGMP messages passing through the AP.

**Multicast Rate:** Adjust the multicast packet data rate here. The multicast rate is supported in AP mode, and WDS with AP mode, including Multi-SSIDs.

**HT20/40 Coexistence:** Enable this option to reduce interference from other wireless networks in your area. If the channel width is operating at 40MHz and there is another wireless network's channel overlapping and causing interference, the Access Point will automatically change to 20MHz.

**Greenfield:** Enable this option to reduce interference from other wireless networks in your area. If the channel width is operating at 40MHz and there is another wireless network's channel overlapping and causing interference, the router will automatically change to 20MHz.

**Transfer DHCP Offer to Unicast:** Enable to transfer the DHCP Offer to Unicast from LAN to WLAN, suggest to enable this function if stations number is larger than 30.

The screenshot displays the D-Link DAP-3315 web interface. The top navigation bar includes links for Operation Mode, Maintenance, Status, Configuration, System, Logout, and Help. The left sidebar shows a tree view of settings categories: Basic Settings (Wireless, LAN), Advanced Settings (Performance, Wireless Resource, Multi-SSID, Internal RADIUS Server, RADIUS Accounts, VLAN, Intrusion), DHCP Server, Filters, WLAN Partition, Schedule, and Log. The main content area is titled "Performance Settings" and contains the following configuration options:

- Wireless: On
- Wireless Mode: Mixed 802.11b, 802.11g, 802.11n
- Data Rate: Best(Up to 300) Mbps
- Beacon Interval (40-500): 100
- DTIM Period (1-15): 1
- Transmit Power: 100%
- WMM (Wi-Fi Multimedia): Enable
- Ack Time Out: 64 (us)
- Short GI: Enable
- IGMP Snooping: Disable
- Multicast Rate: Disable Mbps
- HT 20/40 Coexistence: Enable
- Greenfield: Enabled
- Transfer DHCP Offer to Unicast: Disable

A "Save" button is located at the bottom right of the settings area.

# Wireless Resource

**Wireless Band:** 2.4GHz(DAP-3315 is 2.4GHz Access Point)

**Connection Limit:** Select Enable or Disable. This is an option for load balancing. This determines whether to limit the number of users accessing this device. The exact number is entered in the User Limit field below. This feature allows the user to share the wireless network traffic and the client using multiple APs. If this function is enabled and when the number of users exceeds this value, or the network utilization of this AP exceeds the percentage that has been specified, the DAP-3315 will not allow clients to associate with the AP.

**User Limit:** Set the maximum amount of users that are allowed access (zero to 64 users) to the device using the specified wireless band. The default setting is 20.

**Aging out:** Use the drop-down menu to select the criteria of disconnecting the wireless clients. Available options are RSSI and Data Rate.

**RSSI Threshold:** When RSSI is selected in the Aging out drop-down menu, select the percentage of RSSI here. When the RSSI of wireless clients is lower than the specified percentage, the device disconnects the wireless clients.

The screenshot shows the D-Link configuration interface for a DAP-3315 device. The page title is "D-Link" and the device model is "DAP-3315". The navigation menu includes "Operation Mode", "Maintenance", "Status", "Configuration", "System", "Logout", and "Help". The left sidebar shows a tree view of settings: "DAP-3315" (expanded) contains "Basic Settings" (Wireless, WDS, LAN) and "Advanced Settings" (Performance, Wireless Resource, Multi-SSID, VLAN, Intrusion, Schedule, DHCP Server, Filters, Log). The main content area is titled "Wireless Resource Control" and contains the following settings:

Wireless Band	2.4GHz
Connection Limit	Disable
User Limit (1 - 64)	50
Aging out	Disable
RSSI Threshold	-80 dB
Data Rate Threshold	54
ACL RSSI	Disable
ACL RSSI Threshold	-80 dB

A "Save" button is located at the bottom right of the configuration area.

**Data Rate Threshold:** When Data Rate is selected in the Aging out drop-down menu, select the threshold of data rate here. When the data rate of wireless clients is lower than the specified number, the device disconnects the wireless clients.

**ACL RSSI:** Use the drop-down menu to Enable the function. When enabled, the device denies the connection request from the wireless clients with the RSSI lower than the specified threshold below.

**ACL RSSI Threshold:** Set the ACL RSSI Threshold.



The screenshot displays the D-Link configuration web interface for a DAP-3315 device. The top navigation bar includes 'Operation Mode', 'Maintenance', 'Status', 'Configuration', 'System', 'Logout', and 'Help'. The left sidebar shows a tree view of configuration categories: Basic Settings (Wireless, WDS, LAN), Advanced Settings (Performance, Wireless Resource, Multi-SSID, VLAN, Intrusion, Schedule), DHCP Server, Filters, and Log. The main content area is titled 'Wireless Resource Control' and contains the following settings:

Setting	Value
Wireless Band	2.4GHz
Connection Limit	Disable
User Limit (1 - 64)	50
Aging out	Disable
RSSI Threshold	-80 dB
Data Rate Threshold	54
ACL RSSI	Disable
ACL RSSI Threshold	-80 dB

A 'Save' button is located at the bottom right of the configuration area.

# Multi-SSID

The device supports up to eight multiple Service Set Identifiers. In the **Basic > Wireless** section, you can set the Primary SSID. The SSID's factory default setting is **dlink**. The SSID can be easily changed to connect to an existing wireless network or to establish a new wireless network.

**SSID:** Service Set Identifier (SSID) is the name designated for a specific wireless local area network (WLAN).

**Enable Multi-SSID:** Check to enable support for multiple SSIDs.

2.4GHz(DAP-3315 is 2.4GHz Access Point)

**Wireless Band:**

You can select up to seven multi-SSIDs. With the Primary SSID, you have a total of eight multi-SSIDs.

**Index:**

**SSID Visibility:** **Enable** or **Disable** SSID visibility. Enabling this feature broadcasts the SSID across the network, thus making it visible to all network users.

**Security:** The Multi-SSID security can be Open System, WPA Personal, or WPA-Enterprise. For a detailed description of the Open System parameters please go to page 18. For a detailed description of the WPA-Personal parameters please go to page 19. For a detailed description of the WPA-Enterprise parameters please go to page 20.

**Priority:** Select the priority level of the SSID selected.

The screenshot shows the D-Link DAP-3315 web interface. The main content area is titled "Multi-SSID Settings". It contains the following sections:

- Wireless Settings:**
  - Enable Multi-SSID
  - Enable Priority
  - Band: 2.4GHz
  - Index: Primary SSID
  - SSID: dlink
  - SSID Visibility: Enable
  - Security: Open System
  - Priority: 0
- Key Settings:**
  - Encryption:  Disable  Enable
  - Key Type: ASCII
  - Key Size: 64 Bits
  - Key Index (1-4): 1
  - Network Key: (0-9,a-z,A-Z,-!@#%&^&(\*)\_+':=;{}|~./<>?)

At the bottom right of the settings area is an "Add" button. Below the settings is a table with the following data:

Index	SSID	Band	Authentication Method	Encryption Type	Delete
Primary SSID	dlink	2.4G Hz	No Authentication	No Encryption	

At the bottom right of the table is a "Save" button.

# VLAN

The DAP-3315 supports VLANs. VLANs can be created with a Name and VID. Mgmt (TCP stack), LAN, Primary/Multiple SSID, and WDS connection can be assigned to VLANs as they are physical ports. Any packet which enters the DAP-3315 without a VLAN tag will have a VLAN tag inserted with a PVID. The VLAN List tab displays the current VLANs.

**VLAN Status:** Use the radio button to toggle between **Enable** or **Disable**. After changing the option, you will need to click on **Save** to add or edit VLANs.

To remove or modify a VLAN, click on the **Delete** or **Edit** button.

To add a VLAN, click on the **Create VLAN** button.

**VLAN Mode:** The current VLAN mode is displayed.

The screenshot shows the D-Link DAP-3315 web interface. The top navigation bar includes 'Operation Mode', 'Maintenance', 'Status', 'Configuration', 'System', 'Logout', and 'Help'. The left sidebar shows a tree view of configuration options, with 'VLAN' selected under 'Advanced Settings'. The main content area is titled 'VLAN Settings' and contains the following elements:

- VLAN Status:  Disable  Enable
- VLAN Status: Static(2.4G)
- Buttons: Save
- Navigation tabs: VLAN List, Port List, Add/Edit VLAN, PVID Setting
- Table with columns: VID, VLAN Name, Untag VLAN Ports, Tag VLAN Ports, Edit, Delete

VID	VLAN Name	Untag VLAN Ports	Tag VLAN Ports	Edit	Delete
1	default	Mgmt, LAN1, LAN2, Primary(2.4G), S-1(2.4G), S-2(2.4G), S-3(2.4G), S-4(2.4G), S-5(2.4G), S-6(2.4G), S-7(2.4G), W-1(2.4G)		Edit	Delete

## Port List

The **Port List** tab displays the current ports. If you want to configure the guest and internal networks on a Virtual LAN (VLAN), the switch and DHCP server you are using must also support VLANs. As a prerequisite step, configure a port on the switch for handling VLAN tagged packets as described in the IEEE 802.1Q standard.

**VLAN Status:** Use the radio button to toggle to Enable. Next, go to the Add/Edit VLAN tab to add or modify an item on the VLAN List tab.

**Port Name:** The name of the port is displayed in this column.

**Tag VID:** The Tagged VID is displayed in this column.

**Untag VID:** The Untagged VID is displayed in this column.

**PVID:** The Port VLAN Identifier is displayed in this column.

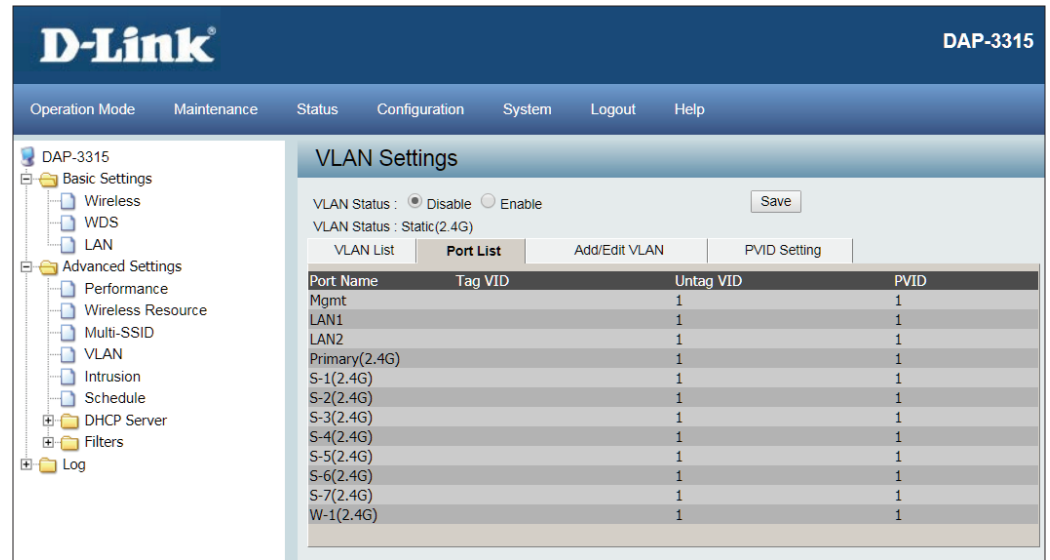

The screenshot shows the D-Link DAP-3315 web interface. The top navigation bar includes 'Operation Mode', 'Maintenance', 'Status', 'Configuration', 'System', 'Logout', and 'Help'. The left sidebar shows a tree view with 'Basic Settings' (Wireless, WDS, LAN) and 'Advanced Settings' (Performance, Wireless Resource, Multi-SSID, VLAN, Intrusion, Schedule, DHCP Server, Filters, Log). The main content area is titled 'VLAN Settings' and includes a 'Save' button. Below the settings, there are tabs for 'VLAN List', 'Port List', 'Add/Edit VLAN', and 'PVID Setting'. The 'Port List' tab is active, showing a table with the following data:

Port Name	Tag VID	Untag VID	PVID
Mgmt		1	1
LAN1		1	1
LAN2		1	1
Primary(2.4G)		1	1
S-1(2.4G)		1	1
S-2(2.4G)		1	1
S-3(2.4G)		1	1
S-4(2.4G)		1	1
S-5(2.4G)		1	1
S-6(2.4G)		1	1
S-7(2.4G)		1	1
W-1(2.4G)		1	1



## Add/Edit VLAN

The **Add/Edit VLAN** tab is used to configure VLANs. Once you have made the desired changes, click the **Save** button to let your changes take effect.

**VLAN Status:** Use the radio button to toggle to Enable.

**VLAN ID:** Provide a number between 1 and 4094 for the Internal VLAN.

**VLAN Name:** Enter the VLAN to add or modify.

**D-Link** DAP-3315

Operation Mode Maintenance Status Configuration System Logout Help

DAP-3315

- Basic Settings
  - Wireless
  - LAN
- Advanced Settings
  - Performance
  - Wireless Resource
  - Multi-SSID
  - Internal RADIUS Server
  - RADIUS Accounts
  - VLAN
  - Intrusion
  - DHCP Server
  - Filters
  - WLAN Partition
  - Schedule
- Log

### VLAN Settings

VLAN Status :  Disable  Enable Save

VLAN Status : Static(2.4G)

VLAN List Port List **Add/Edit VLAN** PVID Setting

VLAN ID (VID)  VLAN Name

Port	Select All	Mgmt	LAN1	LAN2
Untag	All	<input checked="" type="radio"/>	<input checked="" type="radio"/>	<input checked="" type="radio"/>
Tag	All	<input type="radio"/>	<input type="radio"/>	<input type="radio"/>
Not Member	All	<input type="radio"/>	<input type="radio"/>	<input type="radio"/>

**2.4GHz**

MSSID Port	Select All	Primary	S-1	S-2	S-3	S-4	S-5	S-6	S-7
Untag	All	<input checked="" type="radio"/>	<input checked="" type="radio"/>	<input checked="" type="radio"/>	<input checked="" type="radio"/>	<input checked="" type="radio"/>	<input checked="" type="radio"/>	<input checked="" type="radio"/>	<input checked="" type="radio"/>
Tag	All	<input type="radio"/>	<input type="radio"/>	<input type="radio"/>	<input type="radio"/>	<input type="radio"/>	<input type="radio"/>	<input type="radio"/>	<input type="radio"/>
Not Member	All	<input type="radio"/>	<input type="radio"/>	<input type="radio"/>	<input type="radio"/>	<input type="radio"/>	<input type="radio"/>	<input type="radio"/>	<input type="radio"/>

WDS Port	Select All	W-1
Untag	All	<input checked="" type="radio"/>
Tag	All	<input type="radio"/>
Not Member	All	<input type="radio"/>

Save

## PVID Settings

The **PVID Setting** tab is used to enable/disable the Port VLAN Identifier Auto Assign Status as well as to configure various types of PVID settings. Click the **Save** button to let your changes take effect.

**VLAN Status:** Use the radio button to toggle between Enable and Disable.

**PVID Auto Assign Status:** Use the radio button to toggle PVID auto assign status to Enable.

The screenshot shows the D-Link DAP-3315 web interface. The top navigation bar includes 'Operation Mode', 'Maintenance', 'Status', 'Configuration', 'System', 'Logout', and 'Help'. The left sidebar shows a tree view with 'Basic Settings' (Wireless, WDS, LAN) and 'Advanced Settings' (Performance, Wireless Resource, Multi-SSID, VLAN, Intrusion, Schedule, DHCP Server, Filters, Log). The main content area is titled 'VLAN Settings' and includes a 'Save' button. Below this, there are tabs for 'VLAN List', 'Port List', 'Add/Edit VLAN', and 'PVID Setting'. The 'PVID Setting' tab is active, showing 'PVID Auto Assign Status' with 'Disable' selected. Below this are three tables for PVID settings:

Port	Mgmt	LAN1	LAN2
PVID	1	1	1

2.4GHz

MSSID Port	Primary	S-1	S-2	S-3	S-4	S-5	S-6	S-7
PVID	1	1	1	1	1	1	1	1

WDS Port

WDS Port	W-1
PVID	1

A 'Save' button is located at the bottom right of the configuration area.

# Intrusion

The **Wireless Intrusion Protection** window is used to set APs as All, Valid, Neighborhood, Rogue, and New. Click the **Save** button to let your changes take effect.

**Wireless Band:** 2.4GHz.

**AP List:** The choices include All, Valid, Neighbor, Rogue, and New.

**Detect:** Click this button to initiate a scan of the network.

The screenshot shows the D-Link DAP-3315 configuration interface. The top navigation bar includes 'Operation Mode', 'Maintenance', 'Status', 'Configuration', 'System', 'Logout', and 'Help'. The left sidebar shows a tree view with 'DAP-3315' expanded, containing 'Basic Settings' (Wireless, WDS, LAN) and 'Advanced Settings' (Performance, Wireless Resource, Multi-SSID, VLAN, Intrusion, Schedule, DHCP Server, Filters, Log). The main content area is titled 'Wireless Intrusion Protection' and features a 'Wireless Monitor' section. In this section, the 'Wireless Band' is set to '2.4GHz'. A 'Detect' button is present. Below it, the 'AP List' dropdown is set to 'All'. A table header is visible with columns: TypeBand, CH, SSID, BSSID, Last Seen, and Status. Below the table are buttons for 'Set as Valid', 'Set as Neighborhood', 'Set as Rogue', and 'Set as New'. At the bottom, there are two radio button options: 'Mark All New Access Points as Valid Access Points' and 'Mark All New Access Points as Rogue Access Points'. A 'Save' button is located in the bottom right corner.

# Schedule

The **Wireless Schedule Settings** window is used to add and modify scheduling rules on the device. Click the **Save** button to let your changes take effect.

**Wireless Schedule:** Use the drop-down menu to enable the device's scheduling feature.

**Name:** Enter a name for the new scheduling rule in the field provided.

**Index:** Use the drop-down menu to select the desired SSID.

**SSID:** This read-only field indicates the current SSID in use. To create a new SSID, go to the Wireless Settings window (Basic Settings > Wireless).

**Day(s):** Toggle the radio button between All Week and Select Day(s). If the second option is selected, check the specific days you want the rule to be effective on.

**All Day(s):** Check this box to have your settings apply 24 hours a day.

**Start Time:** Enter the beginning hour and minute, using a 24-hour clock.

**End Time:** Enter the ending hour and minute, using a 24-hour clock.

**Wireless Schedule Settings**

Wireless Schedule:

**Add Schedule Rule**

Name:

SSID Index:

SSID:

Day(s):  All Week  Selects Day(s)

Sun  Mon  Tue  Wed  Thu  Fri  Sat

All Day(s):

Start Time:  :  (hour:minute, 24 hour time)

End Time:  :  (hour:minute, 24 hour time)  Overnight

**Schedule List**

Name	SSID Index	SSID	Day(s)	Time Frame	Wireless	Edit	DEL
<input type="button" value="Save"/>							

# DHCP Server

## Dynamic Pool Settings

The DHCP address pool defines the range of the IP address that can be assigned to stations in the network. A Dynamic Pool allows wireless stations to receive an available IP with lease time control. If needed or required in the network, the DAP-3315 is capable of acting as a DHCP server.

**Function** Select **Enable** to allow the DAP-3315 to **Enable/Disable:** function as a DHCP server.

**IP Assigned From:** Input the first IP address available for assignment on your network.

**IP Assigned To:** Input the last IP address available for assignment on your network.

**Domain:** Enter the domain name of the network, if applicable. (An example of a domain name is: www.dlink.com.)

**Least Time** The lease time is the period of time before the DHCP server will assign new IP addresses.

The screenshot shows the D-Link DAP-3315 web interface. The top navigation bar includes 'Operation Mode', 'Maintenance', 'Status', 'Configuration', 'System', 'Logout', and 'Help'. The left sidebar shows a tree view with 'DAP-3315' expanded to 'DHCP Server' > 'Dynamic Pool Settings'. The main content area is titled 'Dynamic Pool Settings' and contains the following fields:

- DHCP Server Control:** Function Enable/Disable (Dropdown menu set to 'Disabled')
- Dynamic Pool Settings:**
  - IP Assigned From: Text input field containing '192.168.0.120'
  - IP Assigned To: Text input field containing '192.168.0.140'
  - Domain Name: Text input field containing 'setup.dlink.com'
  - Lease Time: Dropdown menu set to 'One Hour'
  - DNS: Text input field containing '0.0.0.0'

A 'Save' button is located at the bottom right of the configuration area.

## Static Pool Settings

The DHCP address pool defines the range of IP addresses that can be assigned to stations on the network. A static pool allows specific wireless stations to receive a fixed IP without time control.

**Host Name:** Enter a name for the computer or device that will be used to identify the IP address and assigned MAC address.

**Assigned IP:** Use the Static Pool Settings to assign the same IP address to a device every time you start up. The IP addresses assigned in the Static Pool list must NOT be in the same IP range as the Dynamic Pool.

**Assigned MAC Address:** Enter the MAC address of the device requesting association here.

After you have assigned a static IP address to a device via its MAC address, click **Save**; the device will appear in the Assigned Static Pool at the bottom of the screen. You can edit or delete the device in this list.

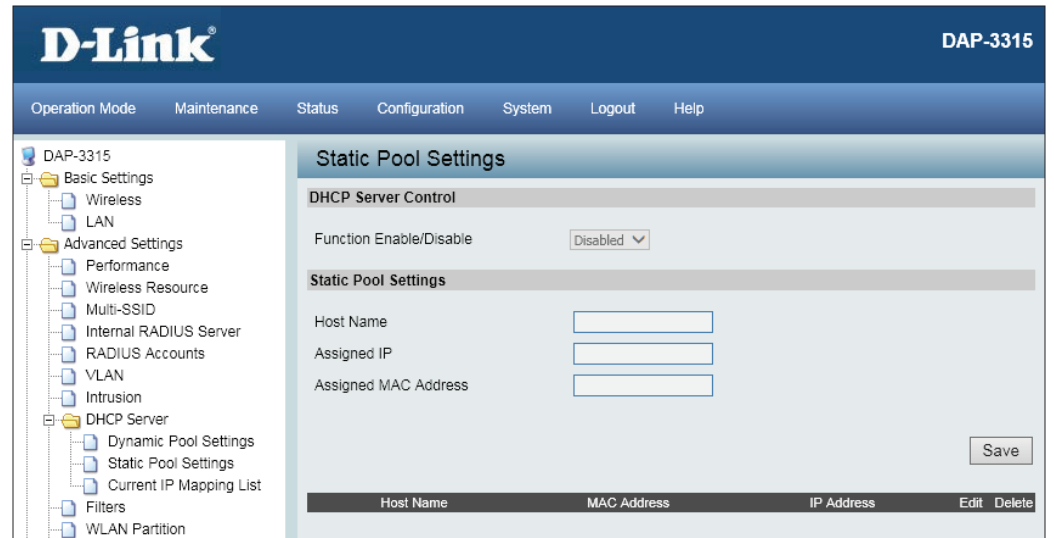

## Current IP Mapping List

This window displays information about the current assigned DHCP dynamic and static IP address pools. This information is available when you enable DHCP server on the AP and assign dynamic and static IP address pools.

**Current DHCP Dynamic Profile:** These are IP address pools the DHCP server has assigned using the dynamic pool setting.

**Binding MAC Address:** The MAC address of a device on the network that is assigned an IP address from the DHCP dynamic pool.

**Assigned IP Address:** The current corresponding DHCP-assigned IP address of the device.

**Lease Time:** The length of time that the dynamic IP address will be valid.

The screenshot shows the D-Link DAP-3315 web interface. The top navigation bar includes 'Operation Mode', 'Maintenance', 'Status', 'Configuration', 'System', 'Logout', and 'Help'. The left sidebar shows a tree view of the configuration menu, with 'DHCP Server' expanded to show 'Dynamic Pool Settings', 'Static Pool Settings', and 'Current IP Mapping List'. The main content area is titled 'Current IP Mapping List' and contains two sections: 'Current DHCP Dynamic Pools' and 'Current DHCP Static Pools'. Both sections have headers with columns for 'Host Name', 'Binding MAC Address', 'Assigned IP Address', and 'Lease Time'. The 'Current DHCP Dynamic Pools' section is currently empty.

# Filter MAC Address ACL

This page allows the user to configure Wireless MAC ACL settings for access control.

**Wireless Band:** Displays the current wireless band rate.

**Access Control List:** Select Disable to **disable** the filters function.

**MAC Address:** Select **Accept** to accept only those devices with MAC addresses in the Access Control List. All other devices not on the list will be rejected.

**MAC Address List:** Select **Reject** to reject the devices with MAC addresses on the Access Control List. All other devices not on the list will be accepted. Enter each MAC address that you wish to include in your filter list, and click Apply. When you enter a MAC address, it appears in this list. Highlight a MAC address and click Delete to remove it from this list.

**Current Client Information:** This table displays information about all the current connected stations.

The screenshot shows the D-Link DAP-3310 configuration interface. The main content area is titled "Wireless MAC ACL Settings". It features an "Access Control List" section with a "Disable" dropdown menu and a "Save" button. Below this is a "MAC Address" input field with an "Add" button. At the bottom, there is a "Current Client Information" table with the following columns: MAC Address, SSID, Authentication, Signal, and Add. The table currently shows a single row with dashes in all columns.

MAC Address	SSID	Authentication	Signal	Add
-	-	-	-	-



## WLAN Partition

This page allows the user to configure a WLAN Partition.

**Wireless Band:** Displays the current wireless band.

**Link Integrity:** Select **Enable** or **Disable**. If the Ethernet connection between the LAN and the AP is disconnected, enabling this feature will cause the wireless segment associated with the AP to be disassociated from the AP.

**Ethernet WLAN Access:** The default is Enable. When disabled, all data from the Ethernet to associated wireless devices will be blocked. Wireless devices can still send data to the Ethernet.

**Internal Station Connection:** The default value is Enable, which allows stations to intercommunicate by connecting to a target AP. When disabled, wireless stations cannot exchange data on the same Multi-SSID. In Guest mode, wireless stations cannot exchange data with any station on your network.

**Guest Mode:** Select this option to disallow communication between wireless clients connected to the same SSID and between wireless clients connected to different SSIDs configured on the access point.

The screenshot shows the D-Link DAP-3315 web interface. The top navigation bar includes links for Operation Mode, Maintenance, Status, Configuration, System, Logout, and Help. The left sidebar shows a tree view with categories like Basic Settings, Advanced Settings, DHCP Server, Filters, and Log. The main content area is titled 'WLAN Partition' and contains the following configuration options:

- Wireless Band:** A dropdown menu set to '2.4GHz'.
- Internal Station Connection:** A table of radio buttons for each SSID, with three columns: Enable, Disable, and Guest mode.

SSID	Enable	Disable	Guest mode
Primary SSID	<input checked="" type="radio"/>	<input type="radio"/>	<input type="radio"/>
Multi-SSID 1	<input checked="" type="radio"/>	<input type="radio"/>	<input type="radio"/>
Multi-SSID 2	<input checked="" type="radio"/>	<input type="radio"/>	<input type="radio"/>
Multi-SSID 3	<input checked="" type="radio"/>	<input type="radio"/>	<input type="radio"/>
Multi-SSID 4	<input checked="" type="radio"/>	<input type="radio"/>	<input type="radio"/>
Multi-SSID 5	<input checked="" type="radio"/>	<input type="radio"/>	<input type="radio"/>
Multi-SSID 6	<input checked="" type="radio"/>	<input type="radio"/>	<input type="radio"/>
Multi-SSID 7	<input checked="" type="radio"/>	<input type="radio"/>	<input type="radio"/>

A 'Save' button is located at the bottom right of the configuration area.

# View Log

The AP's embedded memory holds logs here. The log information includes but is not limited to the following items: cold start AP, upgrading firmware, client associate and disassociate with AP, and web login. The web page holds up to 500 logs.

**View Log:** The AP's embedded memory displays system and network messages including a time stamp and message type. The log information includes but is not limited to the following items: cold start AP, upgrading firmware, client associate and disassociate with AP, and web login. The web page holds up to 500 logs.

The screenshot shows the D-Link DAP-3315 web interface. The top navigation bar includes links for Operation Mode, Maintenance, Status, Configuration, System, Logout, and Help. The left sidebar shows a tree view of configuration options, with 'Log' selected. The main content area displays the 'View Log' page, which includes navigation buttons (First Page, Last Page, Previous, Next, Clear) and a table of log entries. The table has three columns: Date and Time, Category, and Message. The log entries show various system and WLAN events, including link speed changes and client associations/disassociations.

Date and Time	Category	Message
2018/08/08 14:55:58	SYSTEM	LAN, Port[1] link is changed to 100Mbps-Full-Duplex
2018/08/08 13:54:22	SYSTEM	LAN, Port[1] link status is changed to down
2018/08/08 13:49:02	SYSTEM	LAN, Port[1] link is changed to 100Mbps-Full-Duplex
2018/08/08 13:41:19	SYSTEM	LAN, Port[1] link status is changed to down
2018/08/08 10:36:58	SYSTEM	LAN, Port[1] link is changed to 100Mbps-Full-Duplex
2018/08/08 09:14:23	SYSTEM	LAN, Port[1] link status is changed to down
2018/08/08 08:42:28	SYSTEM	LAN, Port[1] link is changed to 100Mbps-Full-Duplex
2018/08/08 08:42:25	SYSTEM	LAN, Port[1] link status is changed to down
2018/08/08 08:42:07	SYSTEM	LAN, Port[1] link is changed to 100Mbps-Full-Duplex
2018/08/08 08:42:01	SYSTEM	LAN, Port[1] link status is changed to down
2018/08/07 17:46:23	WLAN	Wireless 2.4G (SSID1), STA(0c:8b:fd:9a:b0:5a) : disassociated
2018/08/07 17:46:23	WLAN	Wireless 2.4G (SSID1), STA(0c:8b:fd:9a:b0:5a) : associated
2018/08/07 17:46:22	WLAN	Wireless 2.4G (SSID1), STA(0c:8b:fd:9a:b0:5a) : disassociated
2018/08/07 17:46:16	WLAN	Wireless 2.4G (SSID1), STA(0c:8b:fd:9a:b0:5a) : disassociated
2018/08/07 17:46:06	WLAN	Wireless 2.4G (SSID1), STA(0c:8b:fd:9a:b0:5a) : disassociated
2018/08/07 17:46:06	WLAN	Wireless 2.4G (SSID1), STA(0c:8b:fd:9a:b0:5a) : associated

# Log Settings

Enter the log server's IP address to send the log to that server. Check or uncheck System Activity, Wireless Activity, or Notice to specify what kind of log type you want it to log.

**Log Server/IP Address:** Enter the IP address of the server you would like to send the DAP-2660 log to.

**Log Type:** Check the box for the type of activity you want to log. There are three types: System Activity, Wireless Activity, and Notice.

**E-mail Notification:** Support Simple Mail Transfer Protocol for log schedule and periodical change key. It can not support Gmail SMTP port 465. Please set to Gmail SMTP port 25 or 587.

**E-mail Log Schedule:** Use the drop-down menu to set the e-mail log schedule.

The screenshot shows the D-Link DAP-3315 web interface. The top navigation bar includes links for Operation Mode, Maintenance, Status, Configuration, System, Logout, and Help. The left sidebar shows a tree view of the configuration menu, with 'Log Settings' selected under the 'Log' category. The main content area is titled 'Log Settings' and contains two sections:

**Log Settings**

Log Server / IP Address:

Log Type:

- Enable Syslog Server
- System Activity
- Debug Information
- Attacks
- Dropped Packets
- Notice

**Email Notification**

Email Notification:

E-mail Subject:

SMTP Server Address:

SMTP Server Port:

Sender E-mail:

Receiver E-mail:

Authentication:

Save

## DMZ (WISP mode only)

DMZ is short for Demilitarized Zone. If an application has trouble working from behind the router, you can expose a computer to the Internet and run the application on that computer.

**Service:** You can select either **Single DMZ** or **Multiple DMZ**. This will allow you to choose whether to expose a single IP address via DMZ, or to expose multiple IP addresses.

**Note:** Placing a computer in the DMZ may expose that computer to a variety of security risks.

**IP Address:** Specify the IP address of the computer on the LAN that you want to have unrestricted Internet communication. If this computer obtains its IP address automatically using DHCP, be sure to make a static reservation on the **DHCP Server > Static Pool Settings** page so that the IP address of the DMZ machine does not change.

**Public WAN IP Address:** If the Multiple DMZ option is selected, this field will be available. This should be set to the external IP address that will be assigned to an internal IP address of a computer or device.

**Local DMZ IP Address:** If the Multiple DMZ option is selected, this field will be available. This should be set to the internal IP address of a computer or device that will be assigned to an external IP address.

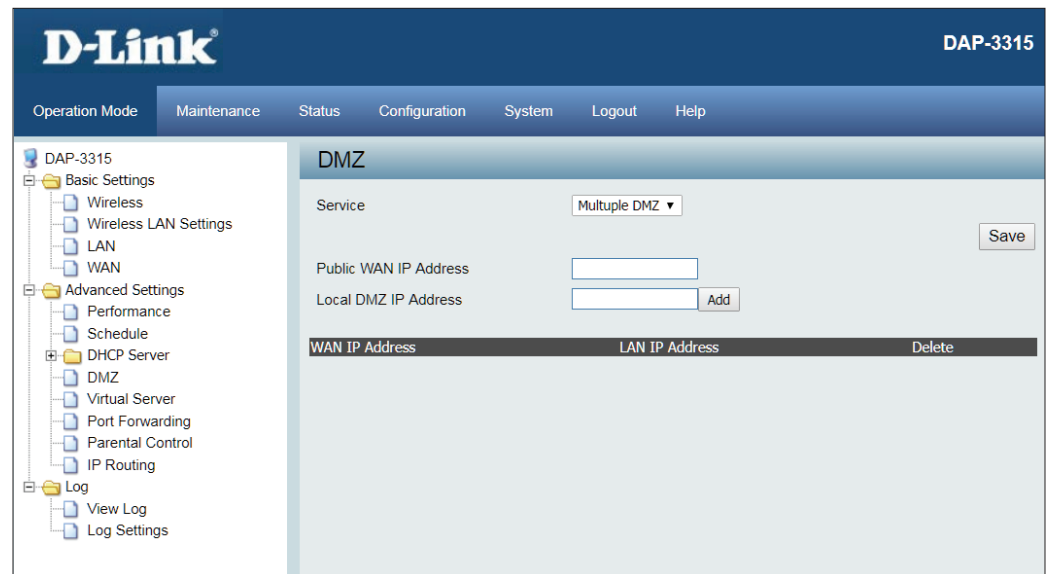
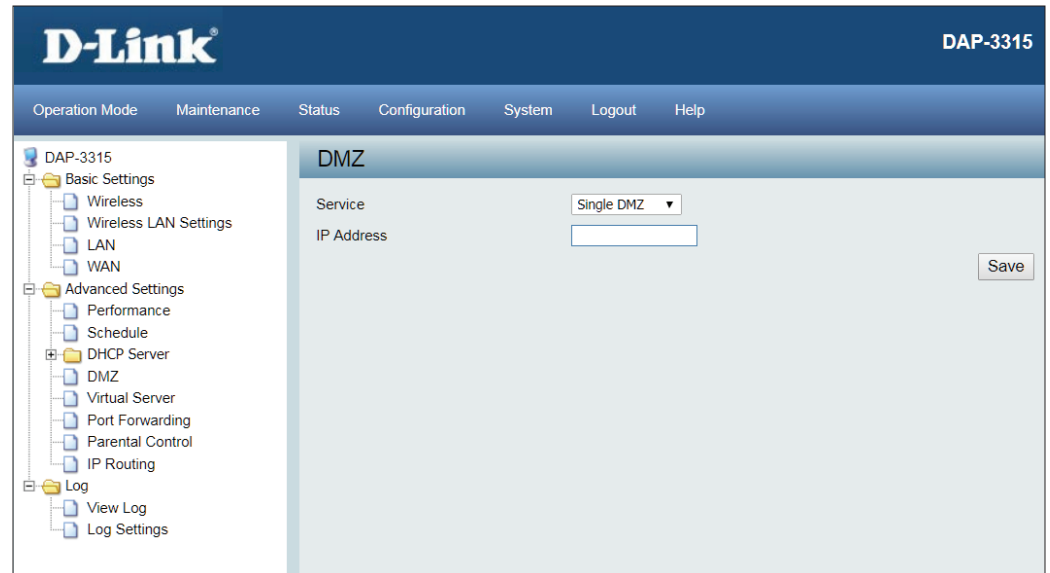

## Virtual Server (WISP mode only)

This will allow you to open a single port. This allows a computer or device to provide external access to services or applications that are otherwise blocked by the built-in firewall. To create a virtual server, click on **Create New Virtual Server**, and the following settings will appear:

**Service:** Select to either **Disable** or **Enable** the rule.

**Description:** Enter a name for the rule.

**Private IP:** Enter the IP address of the computer on your local network that you want to allow the incoming service to.

**Protocol Type:** Select either **TCP** or **UDP**.

**Private Port:** Enter the port that you want to open for the computer or device on the internal network.

**Public Port:** Enter the port that you want to open for the external network.

**Note:** The private and public ports are usually the same. The public port is the port seen from the Internet side, and the private port is the port being used by the application on the computer or device within your local network.

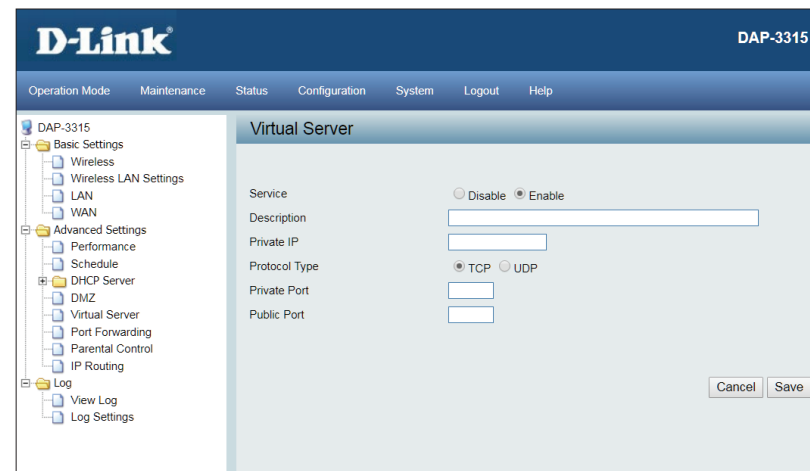
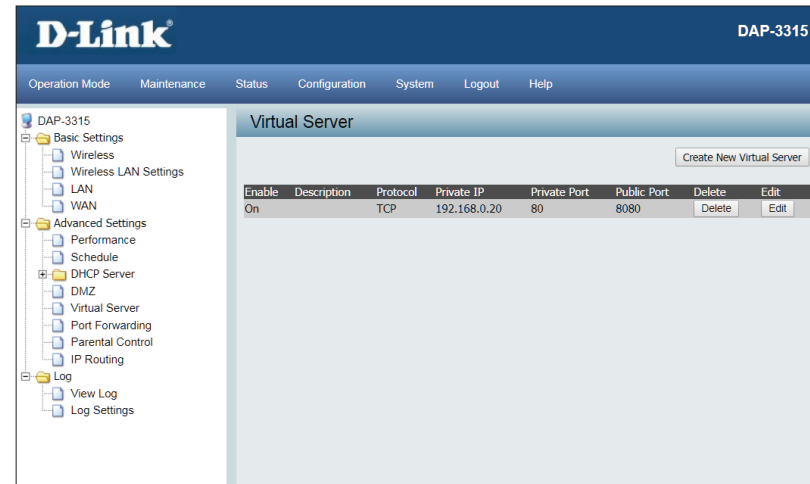

## Port Forwarding (WISP mode only)

This option is used to open multiple ports or a range of ports in this AP and redirect data through these ports to a single PC on your network.

**Rule Name:** Enter a name for the rule.

**Local IP:** Enter the IP address of the computer on your local network that you want to allow the incoming service to.

**Type:** Enter the TCP and/or UDP port or ports that you want to open.

**Port Range:** Enter a single port or a range of ports. Example: 24,1009,3000-4000

The screenshot shows the D-Link DAP-3315 web interface. The top navigation bar includes 'Operation Mode', 'Maintenance', 'Status', 'Configuration', 'System', 'Logout', and 'Help'. The left sidebar shows a tree view of settings: Basic Settings (Wireless, Wireless LAN Settings, LAN, WAN), Advanced Settings (Performance, Schedule, DHCP Server, DMZ, Virtual Server, Port Forwarding, Parental Control, IP Routing), and Log (View Log, Log Settings). The main content area is titled 'Port Forwarding' and contains a 'Port Forwarding Rule (Maximum 15 rules)' section with the following fields: Rule Name (text input), Local IP (text input), Type (dropdown menu set to TCP), and Port Range (text input with a range separator). Below these fields are 'Add' and 'Reset' buttons. The 'Port Forwarding List' section features a table with the following columns: Rule Name, Local IP, Protocol, Port range, and Select. Below the table are 'Delete Selected' and 'Delete All' buttons.

Click **Add** to add this rule or **Reset** to clear settings.

## Parental Control (WISP mode only)

Parental Control is used to allow you to set up a range of IP Addresses that can be either be blacklisted or whitelisted to certain MAC addresses on the network.

**Active:** Select to either **Disable** or **Enable** the Parental Control feature.

**Comment:** You can enter a comment here for each rule that is created.

**MAC Address:** Enter the MAC address to be monitored and click **Save** to add it to the parental control list.

**Local IP:** Enter the start and end of an IP address range that you would like to filter on the local network. This is normally used to prevent access to certain parts of the internal network.

**Destination IP:** Enter the start and end of an IP address range that you would like to filter on the destination network. This is normally used to prevent access to certain parts of the external network.

**Protocol:** Specify which protocol to filter.

**Local Port:** Enter the specific port to filter on the local network.

**Destination Port:** Enter the specific port to filter on the destination network.

The screenshot shows the D-Link DAP-3315 web interface. The top navigation bar includes links for Operation Mode, Maintenance, Status, Configuration, System, Logout, and Help. The left sidebar shows a tree view of settings: Basic Settings (Wireless, Wireless LAN Settings, LAN, WAN), Advanced Settings (Performance, Schedule, DHCP Server, DMZ, Virtual Server, Port Forwarding, Parental Control, IP Routing), and Log (View Log, Log Settings). The main content area is titled 'Parental Control' and contains the following fields:

- Active:** Radio buttons for Enable (selected) and Disable.
- Comment:** A text input field.
- MAC Address:** A text input field with an 'Add' button.
- Local IP:** Two text input fields separated by a hyphen.
- Destination IP:** Two text input fields separated by a hyphen.
- Protocol:** A dropdown menu with 'Any' selected.
- Local Port:** A text input field.
- Destination Port:** A text input field.
- Buttons:** 'Save' and 'Cancel' buttons at the bottom right.

## IP Routing (WISP mode only) Static Routing Setup

This page will allow you to define specific routes that will be broadcasted by the AP and made available to the clients that connect to it.

**Mode:** Select **Enabled** to create static route.

**Destination Net/Mask:** Enter either the destination network, or the subnet mask that will be used in the static route.

**Via:** Select whether the static route will be controlled by an existing gateway, or if the interface on the AP should route the traffic.

**Gateway:** This option becomes available if **Gateway** is selected. Enter the gateway IP address.

The screenshot displays the D-Link DAP-3315 web interface. The top navigation bar includes 'Operation Mode', 'Maintenance', 'Status', 'Configuration', 'System', 'Logout', and 'Help'. The left sidebar shows a tree view of configuration options: Basic Settings (Wireless, Wireless LAN Settings, LAN, WAN), Advanced Settings (Performance, Schedule, DHCP Server, DMZ, Virtual Server, Port Forwarding, Parental Control, IP Routing), and Log (View Log, Log Settings). The main content area is titled 'Routing Tables' and contains the following settings:

- Mode:  Enable  Disable
- Destination Net/Mask:
- Via:  Gateway  Interface
- Gateway:

Buttons for 'Save' and 'Cancel' are located at the bottom right of the form.



# Maintenance Administration Settings

This page will allow you to change a number of settings that are used by the device administrator such as changing the password used to access the device, as well as the method of accessing the device remotely and from what IP address the device can be remotely managed from.

**Limit Administrator IP:** Check this to limit administrator access to specific IP ranges only.

**IP Range:** Enter the IP address range that the administrator will be allowed to log in from and then click the Add button.

**System Name:** Enter a name for the device. The default name is D-Link DAP-3310.

**Description:** Enter a description for the device and its role.

**Location:** Enter the physical location of the device, e.g. 72nd Floor, D-Link HQ.

**Login Name:** Enter a user name. The default is admin.

**Old Password / New Password:** You can change your password by entering the old password, then entering the new password and entering it again to confirm it. The password is case-sensitive and should be between 0 and 12 characters.

**Country Settings:** You can change country domain here. (For some countries such as United States, Japan, Israel and Korea, this selection is grayed out due to regulation limitation.)

The screenshot shows the D-Link DAP-3315 web interface. The top navigation bar includes 'Operation Mode', 'Maintenance', 'Status', 'Configuration', 'System', 'Logout', and 'Help'. The left sidebar shows a tree view of settings categories: Basic Settings (Wireless, Wireless LAN Settings, LAN, WAN), Advanced Settings (Performance, Schedule, DHCP Server, DMZ, Virtual Server, Port Forwarding, Parental Control, IP Routing), and Log (View Log, Log Settings). The main content area is titled 'Administration Settings' and contains the following sections:

- Limit Administrator** (checked):
  - Limit Administrator VLAN ID:  Enable
  - Limit Administrator IP:  Enable
  - IP Range: From  To
  - Table with columns: Item, From, To, Delete
- System Name Settings** (checked):
  - System Name:
  - Location:
- Login Settings** (checked):
  - Login Name:
  - New Password:  (4-32Characters)
  - Confirm Password:  (Confirm)  Apply New Password
- Country Settings** (checked):
  - Select a Country:

## Firmware and SSL Certification Upload

This page allows the user to perform a firmware upgrade. A Firmware upgrade is a function that upgrade the running software used by the access point. This is a useful feature that prevents future bugs and allows for new features to be added to this product. Please go to your local D-Link website to see if there is a newer version firmware available.

**Firmware and SSL Certification Upload:** You can upload files to the access point.

**Upload Firmware from Local Hard Drive:** The current firmware version is displayed above the file location field. After the latest firmware is downloaded, click on the "Choose File" button to locate the new firmware. Once the file is selected, click on the "Open" and "Upload" button to begin updating the firmware. Please don't turn the power off while upgrading.

**Language Pack Upgrade:** Upload specified language pack file to this AP.

**Upload SSL Certification from Local Hard Drive:** After you have downloaded a SSL certification to your local drive, click "Choose File." Select the certification and click "Open" and "Upload" to complete the upgrade.

The screenshot shows the D-Link web interface for a DAP-3315 access point. The page title is "Firmware and SSL Certification Upload". The current firmware version is displayed as "Firmware Version 0.1.2". The interface includes three main sections for file uploads:

- Update Firmware From Local Hard Drive:** Contains a text input field for "Upload Firmware From File:" followed by "Browse..." and "Update" buttons.
- Language Pack Upgrade:** Contains a text input field for "Upload:" followed by "Browse..." and "Update" buttons.
- Update SSL Certification From Local Hard Drive:** Contains two text input fields: "Upload Certificate From File:" and "Upload Key From File:", each followed by "Browse..." and "Update" buttons.

The left sidebar shows a navigation menu with "Basic Settings", "Advanced Settings", and "Log". The top navigation bar includes "Operation Mode", "Maintenance", "Status", "Configuration", "System", "Logout", and "Help".

# Configuration File

This page will allow you to upload or download a configuration file for the DAP-3315.

**Upload File:** Use this option to load a previously saved configuration. Click **Browse** to find a previously saved configuration file. Then, click the **Upload Settings** button to transfer those settings to the access point.

**Load Setting to Local Hard Drive:** Use this option to save the current access point configuration settings to a file on the hard disk of the computer you are using. Click the **Download** button. You will then see a file dialog where you can select a location and file name for the settings.

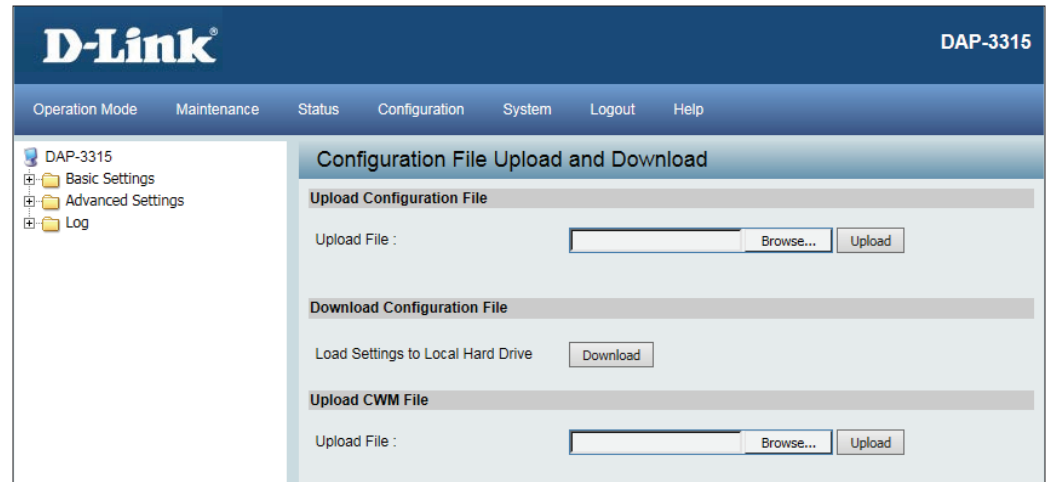

# Time and Date

The Time Server Setup page allows you to configure, update, and maintain the correct time on the internal system clock. In this section you can set the time zone that you are in. Daylight Saving can also be configured to automatically adjust the time when needed.

**Enable NTP** NTP is short for Network Time Protocol. **Server:** This allows the system clock to be updated automatically by using an NTP server.

**NTP Server** Enter the NTP server or select one from the **Used:** drop-down menu.

**Time Zone:** Select the Time Zone from the drop-down menu.

**Daylight Saving Time:** To set Daylight Saving time manually, click the Daylight Saving Time check box. Next, use the drop-down menu to select a Daylight Saving Offset and then enter a start date and an end date for daylight saving time.

**Date and Time:** To manually set the time, enter the Year, Month, Day, Hour, Minute, and Second and then click **Save**. To avoid having to manually set the time, you can also click the **Copy Your Computer's Time Settings** button at the bottom of the page to have the DAP-3315 automatically set the time based on the system clock of the computer being used to configure the DAP-3315.

**D-Link** DAP-3315

Operation Mode Maintenance Status Configuration System Logout Help

DAP-3315

- Basic Settings
  - Wireless
  - WDS
  - LAN
- Advanced Settings
- Log
  - View Log
  - Log Settings

### Time and Date Settings

#### Time Configuration

Current Time 2018/08/07 14:25:42

#### Automatic Time Configuration

Enable NTP Server

NTP Server

Time Zone (GMT) Greenwich Mean Time : Dublin, Edinburgh, Lisbon, London

#### Set the Date and Time Manually

Date And Time

Year 2018 Month Aug Day 8

Hour 16 Minute 50 Second 03

#### Set Daylight Saving Manually

Enable Daylight Saving

DST Start(24 HR) Second Sunday in Mar at 2 : 0

DST End(24 HR) First Sunday in Nov at 2 : 0

DST Offset(minutes) 60

# Status

## Device Information

This page displays the current LAN, wireless LAN and important device information for the DAP-3315.

**Firmware Version:** Displays the access point's time and firmware version. Also displays the current operating mode and hardware address (MAC), which may be needed by a network administrator.

**Wireless:** Displays the wireless your wireless settings such as SSID and Channel along with the current power output of the antennae, data throughput, and wireless security method.

**Ethernet:** Displays the private (local) IP settings for the two built in LAN ports on the access point.

**Device Status:** Displays current system utilization of the access point.

The screenshot shows the D-Link DAP-3315 web interface. The top navigation bar includes 'Operation Mode', 'Maintenance', 'Status', 'Configuration', 'System', 'Logout', and 'Help'. The left sidebar shows a tree view of settings: 'DAP-3315', 'Basic Settings' (Wireless, WDS, LAN), 'Advanced Settings' (Performance, Wireless Resource, Multi-SSID, VLAN, Intrusion, Schedule, DHCP Server, Filters), and 'Log'.

The main content area is titled 'Device Information' and displays the following data:

<b>Firmware Version:0.02 13:17:15 2018/08/09</b>	
Ethernet MAC Address	78:32:1B:05:07:CD
Wireless MAC Address(2.4GHz):	Primary: 78:32:1B:05:07:CD
<b>Ethernet</b>	
IP Address	192.168.0.50
Subnet Mask	255.255.255.0
Default Gateway	192.168.0.1
DNS	---
<b>Wireless(2.4GHz)</b>	
Network Name (SSID)	dlink
Channel	Ch 5 (Auto)
Data Rate	Best(Up to 300) Mbps
Security	No Authentication / No Encryption
<b>Device Status</b>	
CPU Utilization	3%
Memory Utilization	75%

# Client Information

This window displays the wireless client information for clients currently connected to the DAP-3315.

**Client Information:** This window displays the wireless client information for clients currently connected to the DAP-3315.

**SSID:** Displays the SSID of the client.

**MAC:** Displays the MAC address of the client.

**Band:** Displays the wireless band that the client is connected to.

**Authentication:** Displays the type of authentication being used.

**RSSI:** Displays the client's signal strength.

**Power Saving Mode:** Displays the status of the power saving feature.

The screenshot shows the D-Link DAP-3315 web interface. The top navigation bar includes 'Operation Mode', 'Maintenance', 'Status', 'Configuration', 'System', 'Logout', and 'Help'. The left sidebar shows a tree view with 'DAP-3315' expanded, containing 'Basic Settings' (Wireless, WDS, LAN), 'Advanced Settings', and 'Log' (View Log, Log Settings). The main content area is titled 'Client Information' and shows 'Station association (2.4GHz) : 0'. Below this is a table with the following columns: SSID, MAC, Band, Authentication, RSSI (dbm), and Power Saving Mode. The table content is 'No wireless client'.

SSID	MAC	Band	Authentication	RSSI (dbm)	Power Saving Mode
No wireless client					

# Ethernet Information

The DAP-3315 keeps statistics of the traffic that passes through it. You can view the amount of packets that pass through the LAN and wireless portions of the network. The traffic counter will reset if the access point is rebooted.

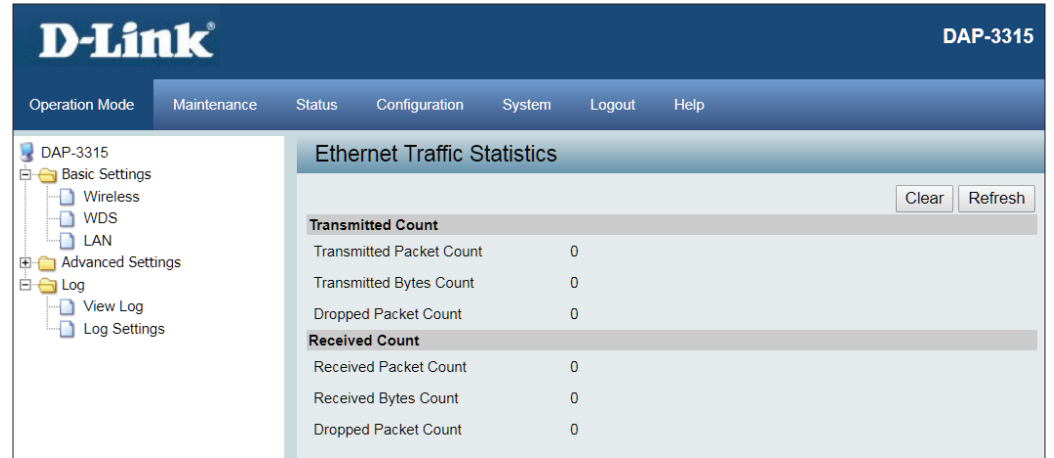

The screenshot displays the D-Link DAP-3315 web interface. The top navigation bar includes 'Operation Mode', 'Maintenance', 'Status', 'Configuration', 'System', 'Logout', and 'Help'. The left sidebar shows a tree view with 'DAP-3315' at the top, followed by 'Basic Settings' (Wireless, WDS, LAN), 'Advanced Settings', and 'Log' (View Log, Log Settings). The main content area is titled 'Ethernet Traffic Statistics' and features a 'Clear' and 'Refresh' button. Below this, there are two sections: 'Transmitted Count' and 'Received Count', each with a table of statistics.

Transmitted Count	
Transmitted Packet Count	0
Transmitted Bytes Count	0
Dropped Packet Count	0

Received Count	
Received Packet Count	0
Received Bytes Count	0
Dropped Packet Count	0

# WLAN Information

This window displays wireless network statistics for data throughput, transmitted and received frames, and frame errors. The traffic counter will reset if the access point is rebooted.

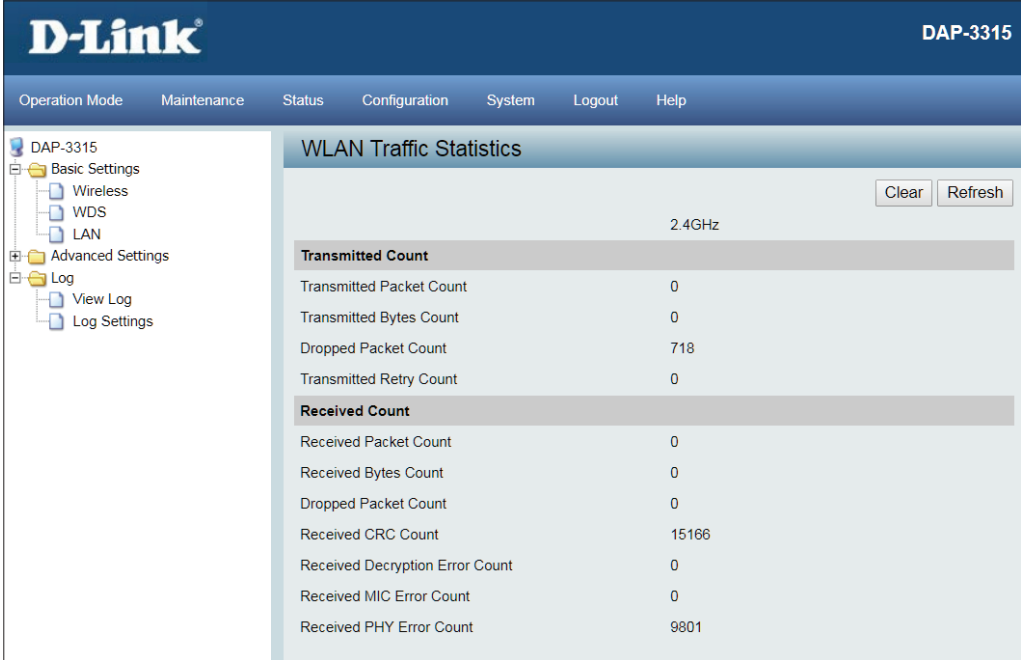

The screenshot shows the D-Link DAP-3315 web interface. The top navigation bar includes links for Operation Mode, Maintenance, Status, Configuration, System, Logout, and Help. The left sidebar shows a tree view of settings: Basic Settings (Wireless, WDS, LAN), Advanced Settings, Log (View Log, Log Settings). The main content area is titled "WLAN Traffic Statistics" and shows data for the 2.4GHz band. It includes a table with transmitted and received counts for various metrics.

2.4GHz	
<b>Transmitted Count</b>	
Transmitted Packet Count	0
Transmitted Bytes Count	0
Dropped Packet Count	718
Transmitted Retry Count	0
<b>Received Count</b>	
Received Packet Count	0
Received Bytes Count	0
Dropped Packet Count	0
Received CRC Count	15166
Received Decryption Error Count	0
Received MIC Error Count	0
Received PHY Error Count	9801



# Configuration

## Save and Activate

When making changes on most of the configuration screens it is best to use the **Save** button at the bottom of each screen to save (not activate) your configuration changes.

You may change settings to multiple pages before activating. Once you are finished, click the **Configuration** button located at the top of the page and then click **Save and Activate**. You can then click **Activate** here to enable your changes.

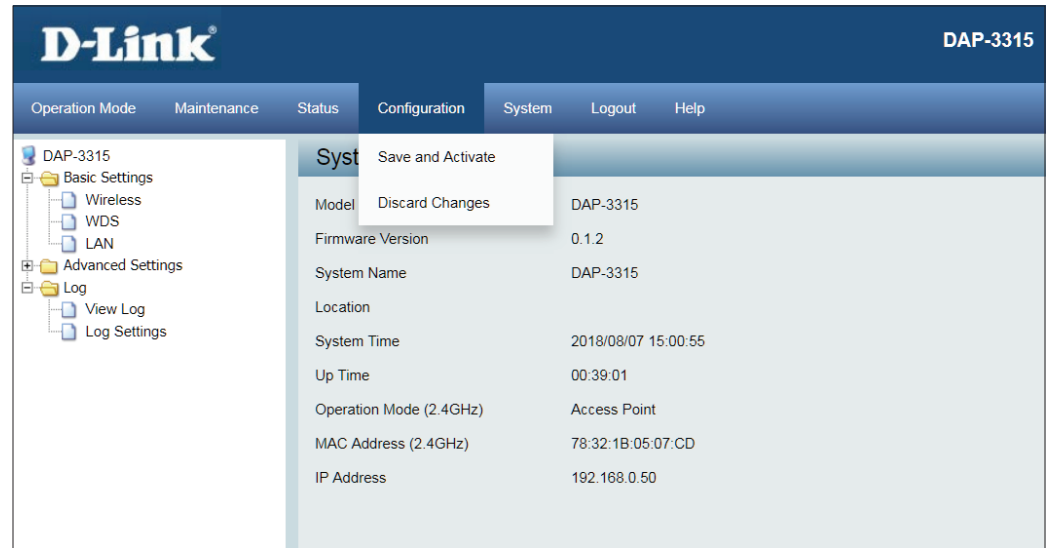

The screenshot displays the D-Link configuration web interface for a DAP-3315 device. The top navigation bar includes tabs for Operation Mode, Maintenance, Status, Configuration, System, Logout, and Help. The left sidebar shows a tree view with folders for Basic Settings (Wireless, WDS, LAN), Advanced Settings, and Log (View Log, Log Settings). The main content area is titled 'System' and contains a table of system information. A dropdown menu is open over the 'Save and Activate' button, showing 'Save and Activate' and 'Discard Changes' options.

Parameter	Value
Model	DAP-3315
Firmware Version	0.1.2
System Name	DAP-3315
Location	
System Time	2018/08/07 15:00:55
Up Time	00:39:01
Operation Mode (2.4GHz)	Access Point
MAC Address (2.4GHz)	78:32:1B:05:07:CD
IP Address	192.168.0.50

## Discard Changes

When making changes on most of the configuration screens it is best to use the **Save** button at the bottom of each screen to save (not activate) your configuration changes.

If you wish to discard all of the changes you have made, and not yet activated, you may click the **Discard** button.

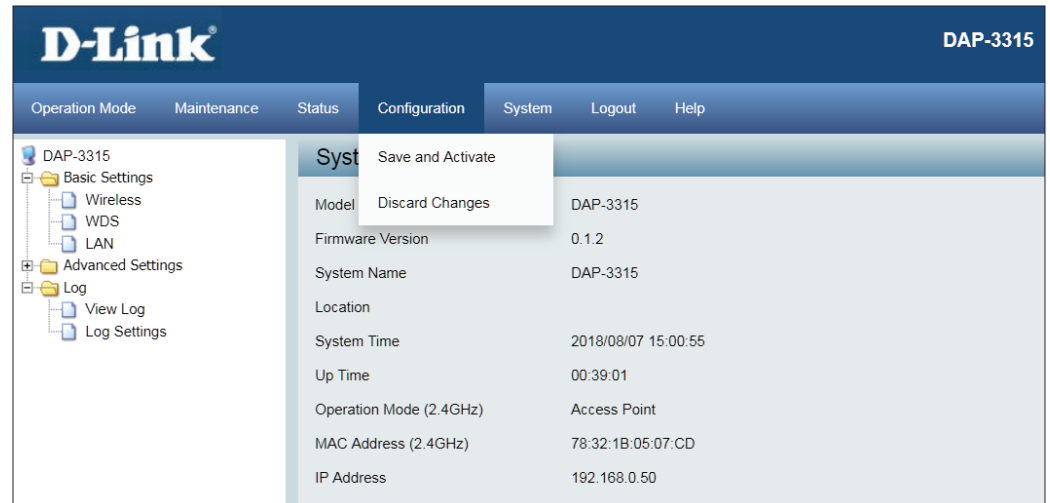

The screenshot shows the D-Link DAP-3315 web interface. The top navigation bar includes 'Operation Mode', 'Maintenance', 'Status', 'Configuration', 'System', 'Logout', and 'Help'. The 'System' tab is selected, and a dropdown menu is open over the 'System' header, showing 'Save and Activate' and 'Discard Changes'. The main content area displays system information:

Model	DAP-3315
Firmware Version	0.1.2
System Name	DAP-3315
Location	
System Time	2018/08/07 15:00:55
Up Time	00:39:01
Operation Mode (2.4GHz)	Access Point
MAC Address (2.4GHz)	78:32:1B:05:07:CD
IP Address	192.168.0.50

# System

This page will allow you to restart the AP, or restore its settings to the factory defaults.

Click the **Restart** button to reboot the device.

Click the **Restore** button to reset all settings back to the factory defaults. Please note that this will erase all settings and changes made to the device's configuration.

Click the Clear button to clear the current Language pack running.

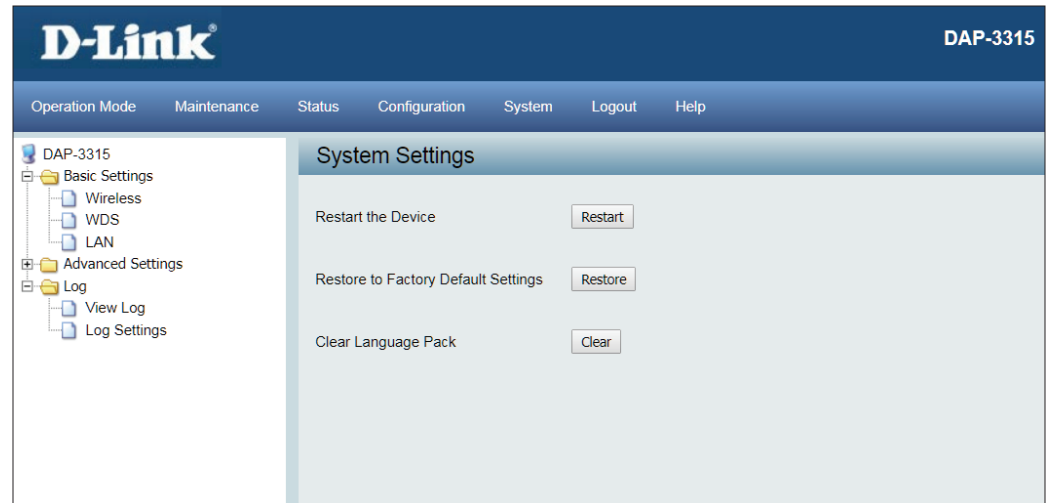

# Help

Further information and in depth help can be found anytime from the AP's online help function. Scroll down the Help page for topics and explanations.

Operation Mode
Select a function mode to configure your wireless network. Function modes include Access Point, WDS with AP, WDS, Wireless Client, Repeater, WISP Client Router and WISP Repeater. Function modes are designed to support various wireless network topology and applications.
Basic Settings
<p><b>Wireless Setting</b></p> <p>Allow you to change the wireless settings to fit an existing wireless network or to customize your wireless network.</p> <p><b>Network Name (SSID)</b> Also known as the Service Set Identifier, this is the name designated for a specific wireless local area network (WLAN). The factory default setting is "dlink". The SSID can be easily changed to connect to an existing wireless network or to establish a new wireless network.</p> <p><b>SSID Visibility</b> Indicate whether or not the SSID of your wireless network will be broadcasted. The default value of SSID Visibility is set to "Enable," which allows wireless clients to detect the wireless network. By changing this setting to "Disable," wireless clients can no longer detect the wireless network and can only connect if they have the correct SSID entered.</p> <p><b>Auto Channel Selection</b> If you check Auto Channel Scan, everytime when AP is booting up, the AP will automatically find the best channel to use. This is enabled by default.</p> <p><b>Channel</b> Indicate the channel setting for the DAP-3310. By default, the AP is set to Auto Channel Scan. The Channel can be changed to fit the channel setting for an existing wireless network or to customize the wireless network.</p> <p><b>Extension Channel</b> Only for Channel Bandwidth 40 MHz. Select the desired channel bonding for control.</p> <p><b>Channel Width</b> Allows selection of the channel width you would like to operate in. 20 MHz and Auto 20/40MHz allow both 802.11n and non-802.11n wireless devices on your network when the wireless mode is Mixed 802.11 b/g/n in 2.4G. 802.11n wireless devices are allowed to transmit data using 40 MHz when the channel width is Auto 20/40 MHz.</p> <p><b>Authentication</b> For added security on a wireless network, data encryption can be enabled. There are several available Authentication types that can be selected. The default value for Authentication is set to "Open System".</p> <ul style="list-style-type: none"> <li>• <b>Open System</b> For Open System authentication, only the wireless clients with the same WEP key will be able to communicate on the wireless network. The Access Point will remain visible to all devices on the network.</li> <li>• <b>Shared Key</b> For Shared Key authentication, the Access Point cannot be seen on the wireless network except to the wireless clients that share the same WEP key.</li> <li>• <b>WPA/WAP2-Personal</b> Wi-Fi Protected Access (WPA) Personal authenticates users onto the wireless network. It uses TKIP encryption to protect the</li> </ul>

# Troubleshooting

This chapter provides solutions to problems that can occur during the installation and operation of the DAP-3315. Read the following descriptions if you are having problems.

## 1. Why can't I access the web-based configuration utility?

When entering the IP address of the D-Link access point (192.168.0.50 for example), you are not connecting to a website on the Internet or have to be connected to the Internet. The device has the utility built-in to a ROM chip in the device itself. Your computer must be on the same IP subnet to connect to the web-based utility.

- Make sure you have an updated Java-enabled web browser. We recommend the following:
  - Internet Explorer 11.0 or higher, Chrome, Firefox, or Safari 7 or higher
- Verify physical connectivity by checking for solid link lights on the device. If you do not get a solid link light, try using a different cable or connect to a different port on the device if possible. If the computer is turned off, the link light may not be on.
- Disable any internet security software running on the computer. Software firewalls such as Zone Alarm, Black Ice, Sygate, Norton Personal Firewall, and Windows® firewall may block access to the configuration pages. Check the help files included with your firewall software for more information on disabling or configuring it.
- Configure your Internet settings:
  - Go to Start > Settings > Control Panel. Double-click the Internet Options Icon. From the Security tab, click the button to restore the settings to their defaults.
  - Click the Connection tab and set the dial-up option to Never Dial a Connection. Click the LAN Settings button. Make sure nothing is checked. Click OK.
  - Go to the Advanced tab and click the button to restore these settings to their defaults. Click OK three times.
  - Close your web browser (if open) and open it.
- Access the web management. Open your web browser and enter the IP address of your D-Link access point in the address bar. This should open the login page for your the web management.
- If you still cannot access the configuration, unplug the power to the access point for 10 seconds and plug back in. Wait about 30 seconds and try accessing the configuration. If you have multiple computers, try connecting using a different computer.

- Configure your Internet settings:

### **2. What can I do if I forgot my password?**

If you forgot your password, you must reset your access point. Unfortunately this process will change all your settings back to the factory defaults.

To reset the access point, locate the reset button (hole) on the rear panel of the unit. With the access point powered on, use a paperclip to hold the button down for 10 seconds. Release the button and the access point will go through its reboot process. Wait about 30 seconds to access the access point. The default IP address is 192.168.0.50. When logging in, the username is Admin and leave the password box empty.

### 3. How to check your IP address?

After you install your network adapter, by default, the TCP/IP settings should be set to obtain an IP address from a DHCP server (i.e. wireless router) automatically. To verify your IP address, please follow the steps below.

Click on Start > Run. In the run box type cmd and click OK.

At the prompt, type ipconfig and press Enter.

This will display the IP address, subnet mask, and the default gateway of your adapter.

If the address is 0.0.0.0, check your adapter installation, security settings, and the settings on your router. Some firewall software programs may block a DHCP request on newly installed adapters.

If you are connecting to a wireless network at a hotspot (e.g. hotel, coffee shop, airport), please contact an employee or administrator to verify their wireless network settings.

```
C:\>ping yahoo.com -f -l 1482
Pinging yahoo.com [66.94.234.13] with 1482 bytes of data:
Packet needs to be fragmented but DF set.
Packet needs to be fragmented but DF set.
Packet needs to be fragmented but DF set.
Packet needs to be fragmented but DF set.

Ping statistics for 66.94.234.13:
    Packets: Sent = 4, Received = 0, Lost = 4 (100% loss),
    Approximate round trip times in milli-seconds:
        Minimum = 0ms, Maximum = 0ms, Average = 0ms

C:\>ping yahoo.com -f -l 1472
Pinging yahoo.com [66.94.234.13] with 1472 bytes of data:
Reply from 66.94.234.13: bytes=1472 time=93ms TTL=52
Reply from 66.94.234.13: bytes=1472 time=109ms TTL=52
Reply from 66.94.234.13: bytes=1472 time=125ms TTL=52
Reply from 66.94.234.13: bytes=1472 time=203ms TTL=52

Ping statistics for 66.94.234.13:
    Packets: Sent = 4, Received = 4, Lost = 0 (0% loss),
    Approximate round trip times in milli-seconds:
        Minimum = 93ms, Maximum = 203ms, Average = 132ms

C:\>
```

# Technical Specifications

## Standards

- IEEE 802.11n/g/b
- IEEE 802.3
- IEEE 802.3u

## Network Management

- Web Browser Interface
- HTTP - Secure HTTP (HTTPS)

## Security

- WPA-Personal & Enterprise
- WPA2-Personal & Enterprise
- WEP 64/128 bit Encryption
- 802.1X

## Wireless Frequency

- 2.4 GHz to 2.4835 GHz

## Operational Modes

- Access Point
- Wireless Distribution System
- Wireless Distribution System with AP
- Wireless Client
- Repeater
- WISP Repeater
- WISP Client

## Antenna

- Built-in 12 dBi directional Antenna

## Maximum Transmit Power Output<sup>1</sup>

- 27 dBm (500 mW)

## Maximum Power Input

- 24V/0.5A

## Maximum Power Consumption

- 10 watts

## LEDs

- Wireless Signal Strength LED
- Power
- LAN
- Wireless

## Operating Temperature

- Operating: -20 to 60 °C (-4 to 140 °F)
- Storage: -20 to 85 °C (-4 to 185 °F)

## Humidity

- Operating: 0 to 90% (non-condensing)
- Storage: 5 to 95% (non-condensing)

## Safety & Emissions

- FCC
- CE

## Dimensions (L x W x H)

- 118 x 56 x 195 mm (4.64 x 2.2 x 7.67 inches)

<sup>1</sup>Range will vary depending on country's maximum transmit power output regulation. Maximum wireless signal rate derived from IEEE Standard 802.11g and 802.11n specifications. Actual data throughput will vary. Network conditions and environmental factors, including volume of network traffic, building materials and construction, and network overhead, lower actual data throughput rate. Environmental conditions will adversely affect wireless signal range.



---

**Trademarks:**

D-Link is a registered trademark of D-Link Corporation/D-Link Systems, Inc. Other trademarks or registered trademarks are the property of their respective owners.

**Copyright Statement:**

No part of this publication or documentation accompanying this product may be reproduced in any form or by any means or used to make any derivative such as translation, transformation, or adaptation without permission from D-Link Corporation/D-Link Systems, Inc., as stipulated by the United States Copyright Act of 1976 and any amendments thereto. Contents are subject to change without prior notice.

Copyright ©2010-2011 by D-Link Corporation/D-Link Systems, Inc. All rights reserved.

**CE Mark Warning:**

This is a Class B product. In a domestic environment, this product may cause radio interference, in which case the user may be required to take adequate measures.

# Antenna Pattern

