

TYXIA RF 642
Wireless receiver - 1 channel

www.deltadore.com

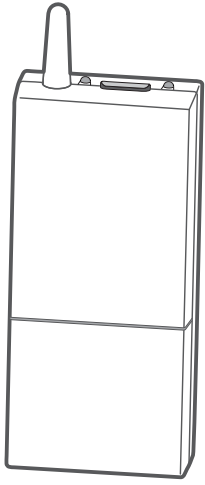

- Carefully read these instructions prior to installation.
- The unit must be installed in compliance with current standards.
- Always switch off the mains before installing or servicing the unit.
- Do not attempt to repair the unit yourself; an after-sales service is available.
- Check that the fastenings are suited to the surface to which the unit will be attached (plasterboard, brick, etc.).
- The diagrams provided are simplified for greater clarity. Protections and other accessories required by standards are not illustrated. Standard and good practice must be complied with. Connected or nearby equipment must not generate excessive interference (directive 2014/30/EU).

1 Presentation

TYXIA RF 642 may be used for two types of application:

- Control of automatic devices: lighting, a garage door or an electric gate,
- Heating control: associated with a transmitter thermostat, it can be connected to a boiler or used to control an electric heating system (via a contactor).

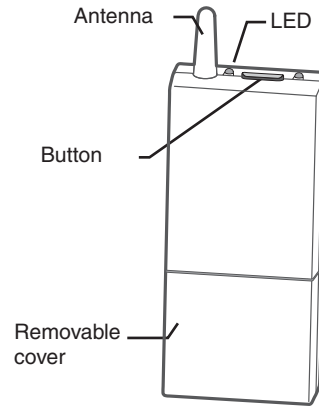

2 Location

The receiver must be placed near the automated device control (electrical switchboard) or heating control (burner or thermostat input for a boiler, electrical switchboard when used with a contact switch). To avoid interference with the radio transmission, the antenna must be free from any metallic elements (cables, electrical switchboard, metallic covers). The receiver power supply must be provided through an electrical cable connected to the 230 V mains.

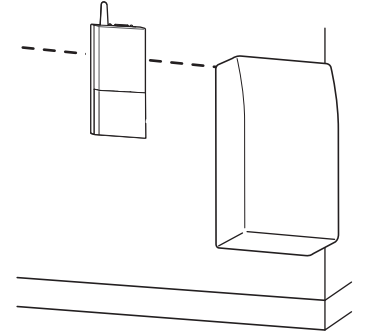

3 Mounting

Removing the cover
To remove the cover, push the tab and lift the cover.

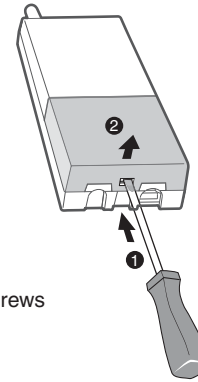

Attachment with screws
Mounted on a wall using the screws and plugs supplied.

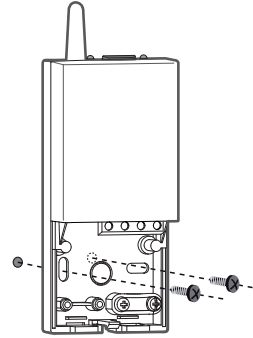

Mounting by double-sided adhesive tape
Mounted on a wall using the double-sided adhesive tape supplied. Ensure that the surface on which the tape is applied is thoroughly clean before mounting.

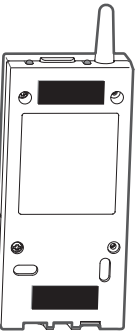

Connection
To connect the control wires, run the wires along the raceway provided or by piercing the hole at 1. Refer to the section that deals with your type of installation.

When the connection is made, fit the cover and switch on the current at the circuit breaker.

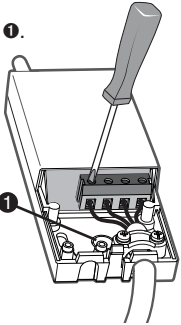

Because of changes in standards and equipment, the characteristics given in the text and the illustrations in this document are not binding unless confirmed by our services.

4 Connection to the heating

Connecting a boiler with thermostat input

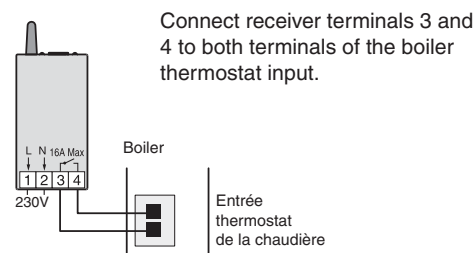

If necessary, remove the shunt (electric wire) connecting the two thermostat input terminals.

Example of a boiler terminal box

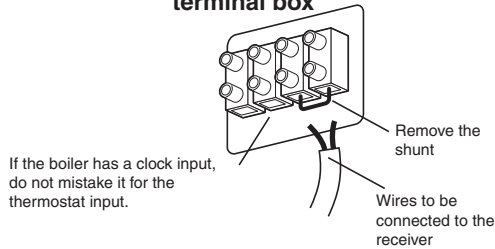

Connecting a boiler without thermostat input

If the boiler does not have a thermostat input, you can directly control the circulator located next to the boiler.

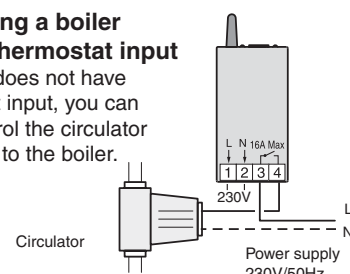

To control electric convectors, you MUST use a power contact switch that is suitable for the total power to be controlled.

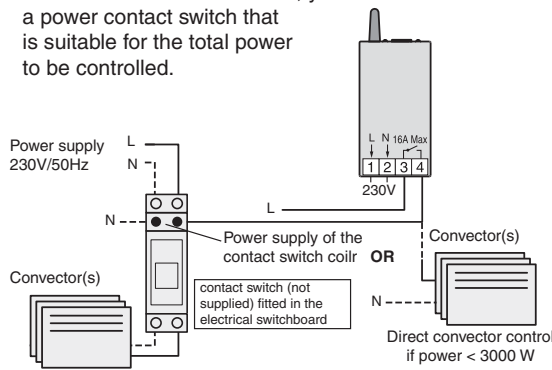

5 Associating the receiver with a transmitter thermostat

On the receiver, press the button until the LED flashes (~3 seconds).

Put the transmitter into association mode (see transmitter guide). Check that the receiver LED is no longer flashing. The receiver is associated with the transmitter.

6 Associating the receiver with a door/window opening detector

When associated with the receiver, a door/window opening detector can prompt the heating to switch automatically to frost protection whenever a window is opened, for example.

On the receiver, press the button until the LED flashes (~3 seconds).
On the door/window opening detector, press the test button.
Check that the receiver LED is no longer flashing. The door/window opening detector is associated with the receiver.

7 Pulse mode (remote control switch, garage door, electric gate)

Connection

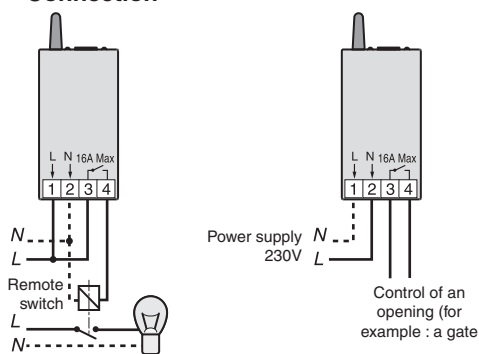

Operation on the TYXIA RF 642
Pressing the button on the receiver changes the current state (on or off).

Operation with an associated TYXIA or TYDOM transmitter

Le mode impulsionnel ne peut être commandé qu'avec une touche o (TYXIA).



On the receiver, press the button until the LED flashes (~3 seconds). You now have two options.

Slow flashing: simple lighting mode

Quick flashing: pulse mode

Press the receiver button briefly to switch from one rate of flashing to the other. Select the quick flashing option.

On the transmitter, press and hold the o button down for 5 seconds. The button will light up, go out then light up again. Release.

Check that the receiver's LED is no longer flashing. The transmitter o button is associated with the receiver in pulse mode.

IMPORTANT: To use the receiver in pulse mode, it must be associated with a transmitter.

8 Simple lighting mode

Connection

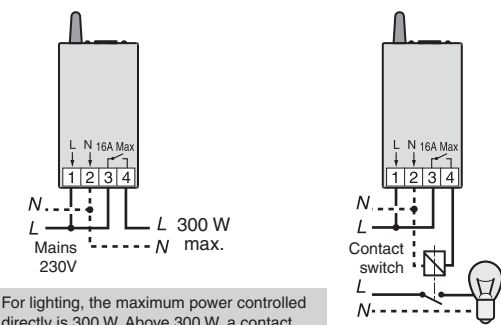

For lighting, the maximum power controlled directly is 300 W. Above 300 W, a contact switch must be used.

Operation on the TYXIA RF 642

Pressing the button on the receiver changes the current state (on or off).

Inverting the relay contact position

During an On command: the relay closes.
During an Off command: the relay opens.
You can invert the operation of the relay by pressing the relevant button on the receiver for about 10 seconds.

Command sent	Contact	Inverted Contact
ON	ON	OFF
OFF	OFF	ON

Simple lighting mode with an associated TYXIA transmitter

The simple lighting mode can be controlled by a TYXIA transmitter (transmitter switch, key ring remote control, etc.).

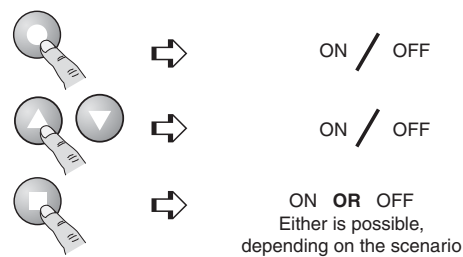

Each function of the receiver can record up to a maximum of 8 associations (buttons, transmitters, etc.).

Associate the button with the receiver

On the receiver, press the button until the LED flashes (~3 seconds). You now have two options.

Slow flashing: simple lighting mode

Quick flashing: pulse mode

Press the receiver button to switch from one rate of flashing to the other. Select the slow flashing option.

On the transmitter, press and hold the button

down for approximately 5 seconds. The button will light up, go out then light up again. Release.

Check that the receiver's LED is no longer flashing.

The transmitter  button is associated with the receiver.



Associate the buttons with the receiver

On the receiver, press the button until the LED flashes (~3 seconds). You now have two options.

Slow flashing: simple lighting mode

Quick flashing: pulse mode.

Press the receiver button to switch from one rate of flashing to the other. Select the slow flashing option.

On the transmitter, press and hold the  and  buttons down together for approximately 5 seconds. The buttons will light up, go out, then light up again. Release. Check that the receiver's LED is no longer flashing.

The transmitter buttons  and  are associated with the receiver.

Associate the button with the receiver

One  button (scenario) can control different receivers simultaneously (roller shutters, dimmer, simple lighting, etc.).

On the receiver,

set the appliance to the required status (e.g. light off), then press the button until the LED flashes (~3 seconds). You now have two options.

Slow flashing: simple lighting mode

Quick flashing: pulse mode.

Press the receiver button to switch from one rate of flashing to the other.

Select the slow flashing option.

On the transmitter, press and hold the  button down for approximately 5 seconds.

The button will light up, go out then light up again. Release.

Check that the receiver's LED is no longer flashing.

The transmitter  button is associated with the receiver.

With an associated TYXAL detector

The simple lighting mode can be associated with a TYXAL detector (opening, movement, technical fault, etc.).

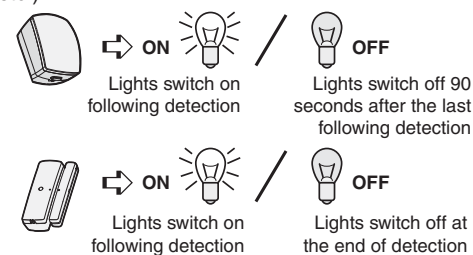

On the receiver, press the button until the LED flashes (~3 seconds).

On the detector, press the Test key (emits a beep). Check that the receiver's LED is no longer flashing.

The detector is associated with the receiver.

The receiver can record up to a maximum of 8 associations (buttons, transmitters, etc.).

With an associated TYXAL control unit

The simple lighting mode can be associated with a TYXAL alarm control unit.

On the control unit, enable the Maintenance mode (see control unit guide).

On the receiver, press the button until the LED flashes (~3 seconds).

Slow flashing:

⇔ Surveillance status transfer

- Light on when surveillance in the control unit is activated

- Light off when surveillance in the control unit is deactivated.

Quick flashing:

⇔ Optical alarm

- Light on for 1min. 30s. in case of alarm.

Press the button to switch from one rate of flashing to the other.

Press the "Test" button of the control unit.

Check that the receiver's LED is no longer flashing.

The control unit is associated with the receiver.

With a associated TYDOM transmitter

The simple lighting mode can be associated with a TYDOM transmitter.

To associate the receiver with TYDOM devices, please refer to the respective guides.

 **TYDOM 3xx telephone transmitter**
TYDOM 3xx enables the ON/OFF feature to be operated remotely.

9 Removing all associations with the receiver

Press and hold the button.
The LED flashes after 3 seconds.
Keep holding down the button.
The relay reverses after 10 seconds and the LED no longer flashes.
Keep holding down the button.
The LED flashes after 30 seconds; all the associations are removed.
Release the button.

10 Troubleshooting

You cannot associate a transmitter with your receiver.

The maximum number of transmitters that can be associated with a receiver function is 8.

Check that this number has not been reached.

Lights only come on for 1 second each time a button is pressed.

Pulse mode is enabled.

Put the unit into simple lighting mode (refer to the "Simple lighting mode" section).

The receiver does not recognize the command from a transmitter.

- The transmitter is not associated with the receiver.
- The receiver is still in association mode.
- The transmitter batteries are low.

No LED lights up on the receiver.

The receiver is not powered.

Check the receiver power supply line.

You want to associate the receiver again.

You must start by removing all the wireless associations (pulse, simple lighting or roller shutters mode)

11 Technical features

- Power supply: 230 V, 50 Hz +/-10%
- Class II insulation
- Consumption: 0.5 VA
- Maximum power: 16 A 230 Veff Cos φ = 1 or 300 W max. for lighting control
- Radio frequency 868 MHz (standard EN 300 220)
- Wireless range 100 to 300 metres outside, variable depending on the associated equipment (the range can be altered depending on the installation conditions and the electromagnetic environment)
- Number of transmitters that may be associated with the receiver: 8 max.
- Automatic action: type 1.C (brownout)
- Operating temperature: -5°C to +50°C
- Storage temperature: -10 to +70°C
- Dimensions: 120 x 54 x 25 mm
- Protection index: IP 44 - IK 04
- Install in an environment with normal pollution levels