



Highbay Performer G4

- NOUVEAU : Très grande efficacité de 145 lm/W
- Solution LED Highbay de qualité supérieure avec design ultra mince
- Équipé d'un connecteur IP68



Caractéristiques

Code d'article	Désignation d'article	Equivalent (W)	Puissance (W)	Lumens	Rendement (lm/W)	CCT (K)	Angle de faisceau	Poids brut (kg/pc)
Marche-Arrêt								
545001002600	LEDHighbay-P4 80W-4000-95D	HID 250W	80	11600	145	4000	95°	2,10

Versions Dali2 compatibles avec luminaire de secours sur source centrale selon la norme EN 50172. Pour plus d'informations techniques, veuillez consulter l'annexe.

Accessoires



545098000500
LEDHighbay-P4 Bracket-D330



545098003500
LEDHighbay-P4 Reflector-D330



543098021900
LEDFixture-IP68-Connector-Kit-3



545098003200
LEDHighbay-Pole and Adapter

Info d'article et emballage

Article			Emballage			
Code d'article	Désignation d'article	Commodity Code	Dimensions (mm) (HxIxL)	Poids brut (kg)	EAN	pc par boîte
545001002600	LEDHighbay-P4 80W-4000-95D	94051190	453x453x131	3,30	6956321897420	1
543098021900	LEDFixture-IP68-Connector-Kit-3	73121049	265x245x205	3,00	6941497708991	1
545098000500	LEDHighbay-P4 Bracket-D330	94059900	163x56x198	0,50	6956321806620	1
545098003200	LEDHighbay-Pole and Adapter	94059900	54.85x335x40	0,61	6941497722324	1
545098003500	LEDHighbay-P4 Reflector-D330	94059900	570x570x210	1,05	6941497726216	1

Caractéristiques

Durée de vie (L70)	70.000 h
Durée de vie (L80)	50.000 h
Cycles marche/arrêt	100.000
Cohérence de couleur (SDCM)	4
Gradabilité	On-Off
Couleur de finition	Gris Pantone 417U
IRC	≥ 80
IP	IP66
IK	IK08
Classe de protection	I
Groupe de risque (EN 62471)	RG1
Pilote inclus (Oui/Non)	Oui
Essai au fil incandescent	850°C
Taux de défaillance du pilote (les 5.000 hrs)	0.5 %
Facteur de puissance	≥ 0,9
Surtension	4 kV

Alimentation électrique

Fréquence	50/60 Hz
Tension	220-240 V AC
DC input voltage	Voir annexe du catalogue
	Connection
	Caractéristiques
Longueur de câble 230V	1 m

Propriétés mécaniques

Structure	Aluminium
UV resistant	Oui
Matériau optique	Polycarbonate
Matériau cover	Polycarbonate

Conditions d'application

Température de fonctionnement	-30-+50°C
Température d'application	+25°C
Environnement de stockage	-25-+50°C



ENERGY

OPPLE Lighting
545001002600

A	
B	
C	C
D	
E	
F	
G	

80
kWh/1000h

2019/2015

Schéma de dimensions (mm)

LEDHighbay-P4
80W & 110W

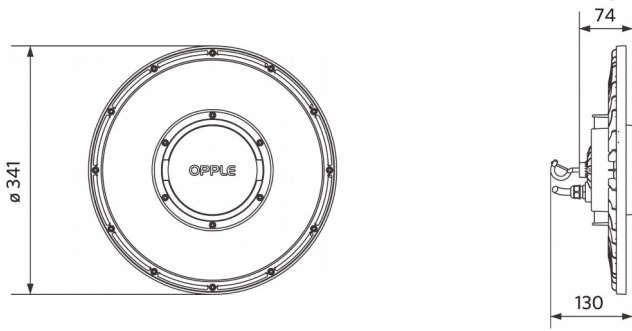

LEDHighbay-P4
155W & 220W

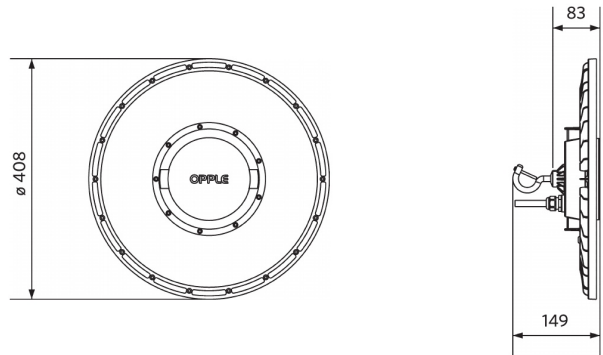

LEDHighbay-P4
80W & 110W Motion Detection

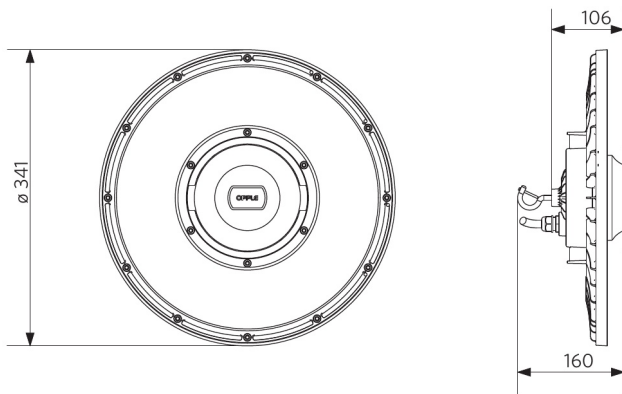

LEDHighbay-P4
155W & 220W Motion Detection

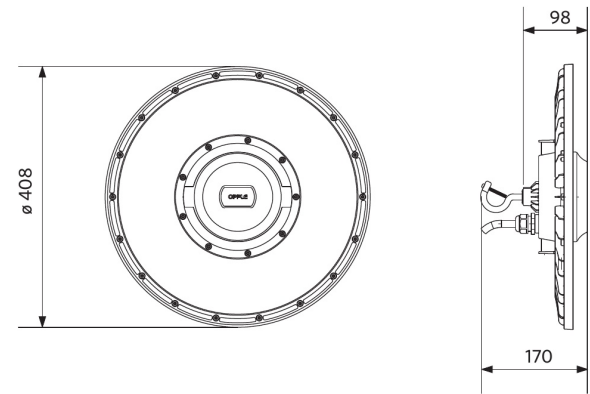

LEDHighbay-P4 Bracket-D330

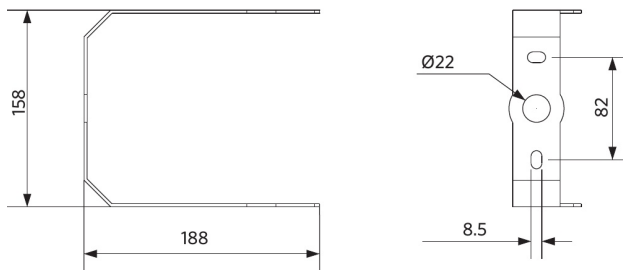

LEDHighbay-P4 Reflector-D330

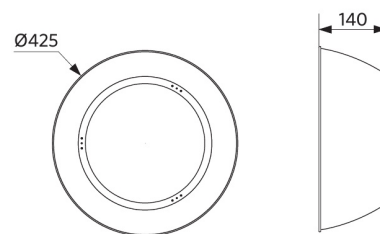

Données photométriques

