



Roadlight EcoMax

- Solution élégante et compacte pour l'éclairage routier
- Conception optique avancée optimisée pour éclairage routier
- Accessoires disponibles pour de nombreux types de mâts et connexions
- Corps robuste en aluminium moulé sous pression
- IP66, adapté aux applications côtières



Caractéristiques

Code d'article	Désignation d'article	Equivalent (W)	Puissance (W)	Lumens	Rendement (lm/W)	CCT (K)	Poids brut (kg/pc)
Marche-Arrêt							
705000021800	LEDRoadlight-E 80W-4000	HID 150W	80	10000	125	4000	3,27

Accessoires



705098003600
LEDStreetlight Wall-Bracket-60



705098003500
LEDStreetlight 76-Adapter-60



705098003700
LEDStreetlight Pole-Top-60-Adapter-60



705098003400
LEDStreetlight Pole-Top-76-Adapter-60



705098005500
LEDStreetlight Pole-Top-60-Adapter-2x60



599000004600
LEDStreet-SE-ExtensionCable-6m



543098021900
LEDFixture-IP68-Connector-Kit-3

Info d'article et emballage

Article			Emballage			
Code d'article	Désignation d'article	EU HS Code	Dimensions (mm) (HxLxL)	Poids brut (kg)	EAN	pc par boîte
705000021800	LEDRoadlight-E 80W-4000	94054239	505x235x87	3,35	6941497734723	1
543098021900	LEDFixture-IP68-Connector-Kit-3	39174000	265x245x205	0,08	6941497708991	1
599000004600	LEDStreet-SE-ExtensionCable-6m	85444290	100x60x350	0,68	6956321815370	1
705098003400	LEDStreetlight Pole-Top-76-Adapter-60	94059900	223x116x314	1,94	6941497755100	1
705098003500	LEDStreetlight 76-Adapter-60	94059900	109x100x221	1,04	6941497755131	1
705098003600	LEDStreetlight Wall-Bracket-60	94059900	201x78x239	1,14	6941497755124	1
705098003700	LEDStreetlight Pole-Top-60-Adapter-60	94059900	215x97x301	1,62	6941497755117	1
705098005500	LEDStreetlight Pole-Top-60-Adapter-2x60	94059900	505x97x230	1,51	6941491705491	1

Caractéristiques	
Durée de vie (L70)	70.000 h
Durée de vie (L80)	50.000 h
Cycles marche/arrêt	100.000
Cohérence de couleur (SDCM)	4
Gradabilité	On-Off
Angle de faisceau	150° x 80°
Couleur de finition	Gris RAL 870-3
IRC	≥ 80
IP	IP66
IK	IK08
Classe de protection	I
Groupe de risque (EN 62471)	RG1
Pilote inclus (Oui/Non)	Oui
Essai au fil incandescent	850°C
Facteur de puissance	≥ 0,9
Surtension	6 kV

Alimentation électrique	
Fréquence	50/60 Hz
Tension AC	220-240 V
DC input voltage	Voir annexe du catalogue Connection Caractéristiques
Longueur de câble 230V	1 m

Propriétés mécaniques	
Structure	Aluminium
Matériau optique	Polycarbonate
Compatible poteau Ø	42-60 mm
Charge de vent efficace	900 cm ²
Résistant à la corrosion côtière	Oui

Conditions d'application	
Température de fonctionnement	-40-+50°C
Température d'application	+25°C
Environnement de stockage	-30-+60°C



OPPLE Lighting
705000021800

A	
B	
C	
D	
E	◀ E
F	
G	

80
kWh/1000h

2019/2015

Schéma de dimensions (mm)

LEDRoadlight-E

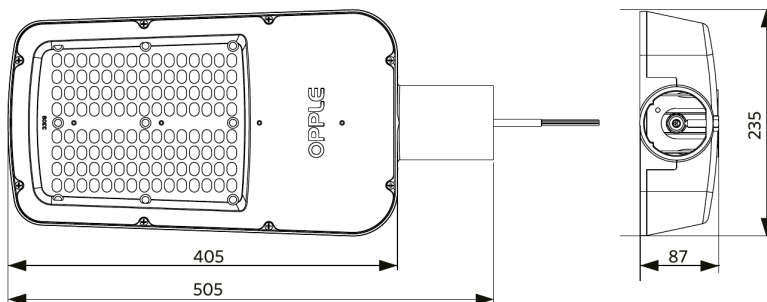

Données photométriques

