















Cloche LED PHB2 est la référence pour l'éclairage des espaces industriels ou des entrepôts. Le PHB2 est équipé d'un boîtier IP65 avec des fentes de ventilation intégrées pour un refroidissement optimal et avec leds SMD3030 haute performance et d'un driver de qualité 1-10V gradable. Le PHB2 est livré en standard avec un couvercle en polycarbonate mat. Efficacité jusqu'à 130lm/W à 4000K, faisceau standard de 110°. Avec le support mural en option, il est possible de monter l'unité en position fixe sur le mur ou le plafond. Options possibles : driver DALI, support mural, protection anti-chute, lentille transparente 60 ou 90°.

														
IP65	IK08	110	5 ANS	jusqu'à 130	0,99	70.000 L80B10	OUI	>80	4000	1-10V	EMC3030	33	OUI	OUI

### Spécifications technique

Reference	PHB21004
EAN code	5420076269067
ETIM code	EC001716

### Spécifications électrique

Puissance système (W)	100,92
Puissance led (W)	99,9
Tension (Vac)	220-240
Fréquence (Hz)	47-63
Contrôleur inclus	oui
Contrôleur in/externe	interne
Driver marque	TCL
Driver référence	150R
Dimmable	1-10V
Flicker free	oui
Power factor	0,99
Taux d'harmonique	<15%
Driver output (V)	
Driver output (mA)	
Classe d'isolation	I
Classe d'énergie	E
N° sur disj. 16A type B	
N° sur disj. 16A type C	7
N° sur disj. 16A type D	12
Inrush current driver	62A

### Garantie et certification

Durée de vie (h)	70.000 L80B10
Garantie (ans)	5 (hors batteries)
ENEC	oui

### Propriétés photométriques

Angle rayonnement (°)	110
Temp. de couleur (K)	4000
Rendu de couleurs CRI	>80
UGR	33
Solidité de couleurs	<5
Sortie de lumen (Lm)	13365
Lm/W	130
Flux code	
Puce led	EMC3030
Fournisseur led	Tiandian
Nombre de puce led	168
Classe photobiologique	RG1

### Dimensions et caractéristiques du matériau

Dimensions (LxlxH)	250x250x136mm
Poids (kg)	2,8
Couleur	noir
Temp. de travail (°C)	-30~+45
Valeur IP	IP65
Valeur IK	IK08
Résistant aux UV	oui
Résistant à l'eau de mer	no
UL94	
Nombre en vrac	1
Nombre sur palette	84
Quantité minimum	1
Article en stock	oui

## PHB21004 Cloche LED PHB2 100W 4000K IP65 1-10V

### Lumen distribution

LUMINOUS INTENSITY DISTRIBUTION DIAGRAM

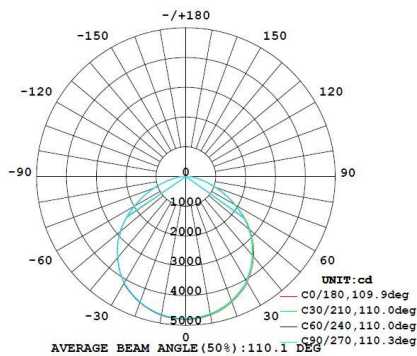

### Spectrum distribution

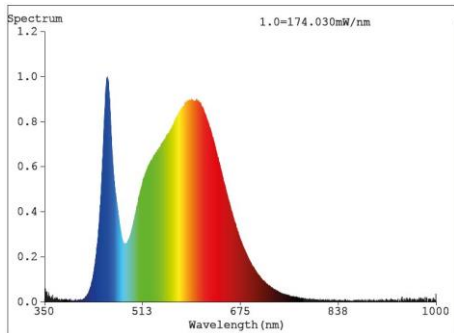



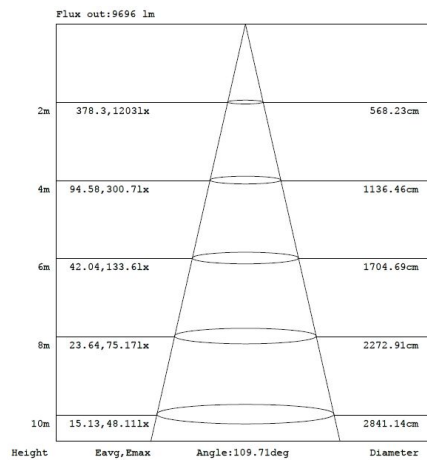

### Distance curve:

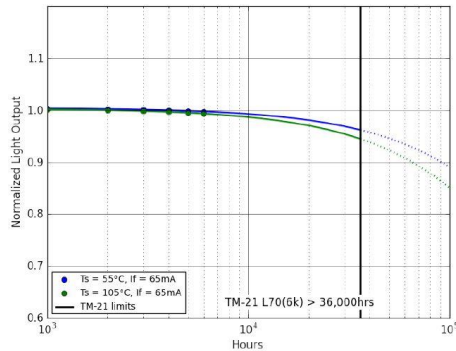

### Lumendrop



### Accessoires

PHB2150-PCC	Reflecteur prisma 100gr PHB2 75/100/150W	
PHB2150-COV	Couvercle réflecteur prismatique PHB2 75/100/150W	
PHB-WBR	Support de montage pour PHB/PHBP	
IP68-connect	Kit de connexion 3 poles 2,5mm² male/female	

## Dimensions

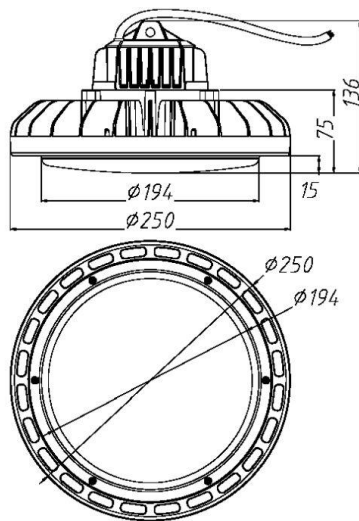

## Schéma de câblage



Isolation test 3,75KVac  
TUV, GS, CB, D Mark, C